

SPECIAL™ 112

S O L O™ S E R I E S
S I N G L E - U N I T G U I T A R A M P

O P E R A T I N G G U I D E





Intended to alert the user to the presence of uninsulated "dangerous voltage" within the product's enclosure that may be of sufficient magnitude to constitute a risk of electric shock to persons.



Intended to alert the user of the presence of important operating and maintenance (servicing) instructions in the literature accompanying the product.

CAUTION: Risk of electrical shock – DO NOT OPEN!

CAUTION: To reduce the risk of electric shock, do not remove cover. No user serviceable parts inside. Refer servicing to qualified service personnel.

WARNING: To prevent electrical shock or fire hazard, do not expose this appliance to rain or moisture. Before using this appliance, read the operating guide for further warnings.



Este símbolo tiene el propósito de alertar al usuario de la presencia de "(voltaje) peligroso" que no tiene aislamiento dentro de la caja del producto que puede tener una magnitud suficiente como para constituir riesgo de corrientazo.



Este símbolo tiene el propósito de alertar al usuario de la presencia de instrucciones importantes sobre la operación y mantenimiento en la literatura que viene con el producto.

PRECAUCION: Riesgo de corrientazo – No abra.

PRECAUCION: Para disminuir el riesgo de corrientazo, no abra la cubierta. No hay piezas adentro que el usuario pueda reparar. Deje todo mantenimiento a los técnicos calificados.

ADVERTENCIA: Para evitar corrientazos o peligro de incendio, no deje expuesto a la lluvia o humedad este aparato. Antes de usar este aparato, lea más advertencias en la guía de operación.



Ce symbole est utilisé pour indiquer à l'utilisateur la présence à l'intérieur de ce produit de tension non-isolée dangereuse pouvant être d'intensité suffisante pour constituer un risque de choc électrique.



Ce symbole est utilisé pour indiquer à l'utilisateur qu'il ou qu'elle trouvera d'importantes instructions sur l'utilisation et l'entretien (service) de l'appareil dans la littérature accompagnant le produit.

ATTENTION: Risques de choc électrique – NE PAS OUVRIR!

ATTENTION: Afin de réduire le risque de choc électrique, ne pas enlever le couvercle. Il ne se trouve à l'intérieur aucune pièce pouvant être réparée par l'utilisateur. Confier l'entretien à un personnel qualifié.

AVERTISSEMENT: Afin de prévenir les risques de décharge électrique ou de feu, n'exposez pas cet appareil à la pluie ou à l'humidité. Avant d'utiliser cet appareil, lisez les avertissements supplémentaires situés dans le guide.



Dieses Symbol soll den Anwender vor unisolierten gefährlichen Spannungen innerhalb des Gehäuses warnen, die von Ausreichender Stärke sind, um einen elektrischen Schlag verursachen zu können.



Dieses Symbol soll den Benutzer auf wichtige Instruktionen in der Bedienungsanleitung aufmerksam machen, die Handhabung und Wartung des Produkts betreffen.

VORSICHT: Risiko – Elektrischer Schlag! Nicht öffnen!

VORSICHT: Um das Risiko eines elektrischen Schlages zu vermeiden, nicht die Abdeckung entfernen. Es befinden sich keine Teile darin, die vom Anwender repariert werden könnten. Reparaturen nur von qualifiziertem Fachpersonal durchführen lassen.

ACHTUNG: Um einen elektrischen Schlag oder Feuergefahr zu vermeiden, sollte dieses Gerät nicht dem Regen oder Feuchtigkeit ausgesetzt werden. Vor Inbetriebnahme unbedingt die Bedienungsanleitung lesen.

ENGLISH

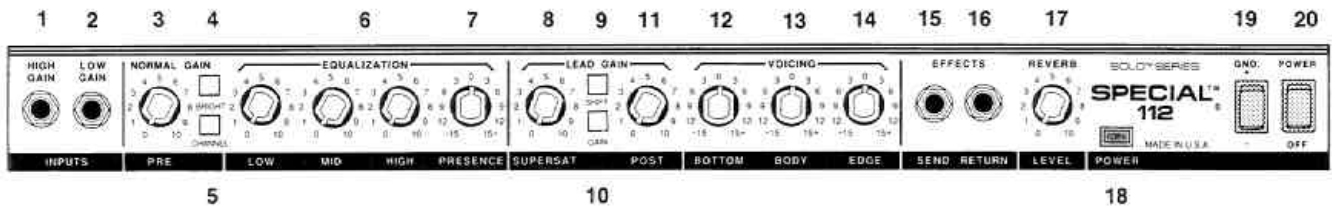

HIGH GAIN INPUT (1)

Used for most electric guitars. It is 6 dB louder than the Low Gain input.

LOW GAIN INPUT (2)

Provided for instruments that have extremely high outputs, which can result in overdriving (distorting) the High Gain input. If both inputs are used simultaneously, the output levels are the same (both are Low Gain).

NORMAL GAIN (3)

Controls the volume level of the Normal channel and is not affected by the SuperSat[®] or Post Gain controls.

BRIGHT SWITCH (4)

Provides a preset boost (6 dB) to treble frequencies. To activate, depress the switch to its “in” position.

CHANNEL SELECT SWITCH (5)

Allows selection of the Lead or Normal channel. The “in” position of the switch selects the Lead channel and the “out” position select Normal.

LOW, MID, & HIGH EQ (6)

Passive tone controls that regulate the low, mid and high frequencies, respectively.

PRESENCE (ACTIVE) (7)

An active tone control (± 15 dB) that varies the extreme high frequency range. 0 to +15 boost (increase), 0 to -15 cut (reduce).

SUPERSAT[®] (8)

A transistor simulation of tube distortion (soft clipping). To activate the SuperSat effect, Lead channel must be activated.

SHIFT SWITCH (9)

Shifts the frequency at which the “Body” control operates. The “In” position allows the Body control to function at a higher frequency and the “Out” position selects a lower frequency.

GAIN SWITCH (10)

Boosts the overall system gain. Depress to the “in” position to activate.

POST GAIN (11)

Controls the overall volume level of the Lead channel. The final level adjustment should be made after the desired sound has been achieved.

BOTTOM (12)

An active tone control (shelving type ± 15 dB) that varies the low frequency boost or cut.

NOTE: This control is not functional on the Normal channel.

BODY (13)

An active tone control (peak/notch, ± 15 dB) that varies the mid frequency boost or cut.

NOTE: This control is not functional on the Normal channel.

EDGE (14)

An active tone control (shelving type, ± 15 dB) that varies the high frequency boost or cut.

NOTE: This control is not functional on the Normal channel.

EFFECTS SEND (15)

Output for supplying signals to external low-level effects or signal processing equipment.

EFFECTS RETURN (16)

Input for returning signals from external low-level effects or signal processing equipment.

REVERB LEVEL (17)

Controls the overall reverb level.

POWER LED (18)

Illuminates when AC power is being supplied to the amp.

GROUND SWITCH (19)

Three position rocker-type switch which, in most applications, should be operated in its center or zero position. There may be some situations when audible hum and/or noise will come from the loudspeaker. If this situation arises, position the ground switch to either positive or negative (+ or -) or until the noise is minimized.

NOTE: Should the noise problem continue, consult your Authorized Peavey Dealer, the Peavey Factory, or a qualified service technician. THE GROUND SWITCH IS NOT FUNCTIONAL ON 220/240 VOLT MODELS.

POWER SWITCH (20)

Depress the switch to the "On" position. The red pilot light (LED) will illuminate indicating power is being supplied to the unit.

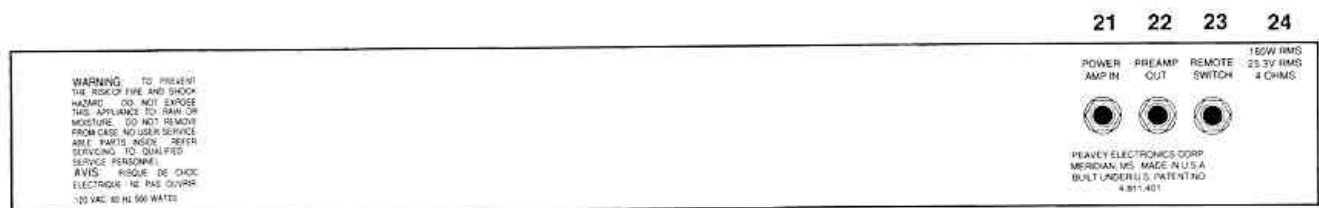
**POWER AMP INPUT (21)**

Use to connect line level signal to the power amplifier.

PREAMP OUT (22)

The preamp output can be used to route the amplified signal to a mixing console, tape recorder, etc. Connect the preamp output using a shielded cable to an input of the tape recorder, mixer, etc. This patch does not affect the operation of the amplifier.

REMOTE SWITCH JACK (23)

Provided for the connection of the supplied remote footswitch. Footswitch is used to select the Lead or Normal channels and defeat reverb. When using remote footswitch, always insert the plug fully (second click) to insure proper operation.

LINE CORD (120V PRODUCTS ONLY) (24)

For your safety, we have incorporated a 3-wire line (mains) cable with proper grounding facilities. It is not advisable to remove the ground pin under any circumstances. If it is necessary to use the equipment without proper grounding facilities, suitable grounding adaptors should be used. Less noise and greatly reduced shock hazard exists when the unit is operated with the proper grounded receptacles.

tone settings

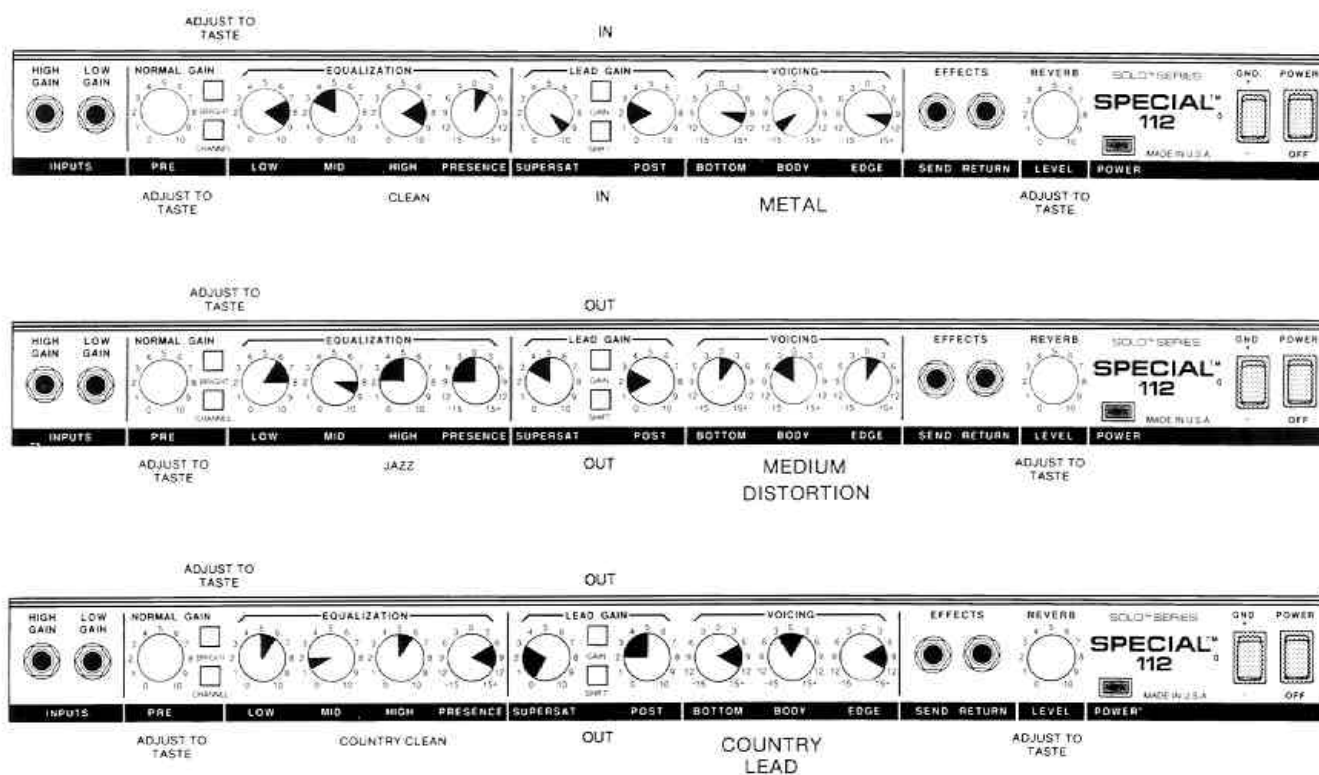

Tone settings given are general and will vary according to type of guitar, type and gauges of strings, type of pickup and even type of pick. Personal taste, playing style, and type of music greatly contribute to desired tonality.

SPECIFICATIONS

POWER AMPLIFIER SECTION

Rated Power & Load:

160 W RMS into 4 ohms

Power @ Clipping: (Typically)

(7% THD, 1 kHz, 120 V AC line)

100 W RMS into 8 ohms

160 W RMS into 4 ohms

2 ohms not recommended

Frequency Response:

+0, -1 dB, 20 Hz to 20 kHz

@ 130 W into 4 ohms

Total Harmonic Distortion:

Less than 0.5%, 100 mW to 130 W RMS, 60 Hz to 10 kHz, 4 ohms, typically below 0.2%

Hum & Noise:

Greater than 85 dB below rated power

Power Consumption:

500 W @ 50/60 Hz, 120 V AC

PREAMP SECTION

The following specs are measured @ 1 kHz with the controls preset as follows:

Push Bright, Off (Out)

Channel Select Normal (Out)

Low & High @ 10

Mid @ 0

Presence @ 0 dB

SuperSat® & Post Gain @ 10

Bottom, Body, & Edge @ 0 dB
Gain & Shift Off (Out)

Normal Levels are with normal gain @ 5

Minimum Levels are with normal gain @ 10

Preamp High Gain Input:

Impedance: High Z, 220 K ohms

Nominal Input Level: -16 dBV,

150 mV RMS

Minimum Input Level: -34 dBV,

20 mV RMS

Maximum Input Level: +16 dBV,

6 V RMS

Preamp Low Gain Input:

Impedance: High Z, 44 K ohms

Nominal Input Level: -10 dBV,

300 mV RMS

Minimum Input Level: -40 dBV,

10 mV RMS

Maximum Output Level:

+22 dBV, 12 V RMS

Effects Send:

Load Impedance: 1 K ohms or greater

Nominal Output Level: -10 dBV,

0.3 V RMS

Effects Return:

Impedance: High Z, 22 K ohms

Designed Input Level: -10 dBV,

0.3 V RMS

(Switching jack providing effects

send to effects return connection

when not used)

Preamp Output:

Load Impedance: 1 K ohms or greater

Nominal Output Level: 0 dBV,

1 V RMS

Power Amp Input:

Impedance: High Z, 30 K ohms

Designed Input Level: 0 dBV,

1 V RMS (Switching jack providing

preamp output to power

amp input connection when not

used)

System Hum & Noise @

Nominal Input Level:

(20 Hz to 20 kHz unweighted)

80 dB below rated power

Equalization (Normal Channel Only)

Special low, mid & high passive type EQ

Presence: ±15 dB @ 5 kHz,

shelving (active)

Push Bright: +6 dB @ 2 kHz

Voicing:

Special Bottom, Body, & Edge active type EQ

Push Shift: Shifts Body effect

Push Gain: Increases SuperSat® gain

External Footswitch Function:

Reverb defeat (when reverb control is raised)

Lead channel defeat (when

selected with button)

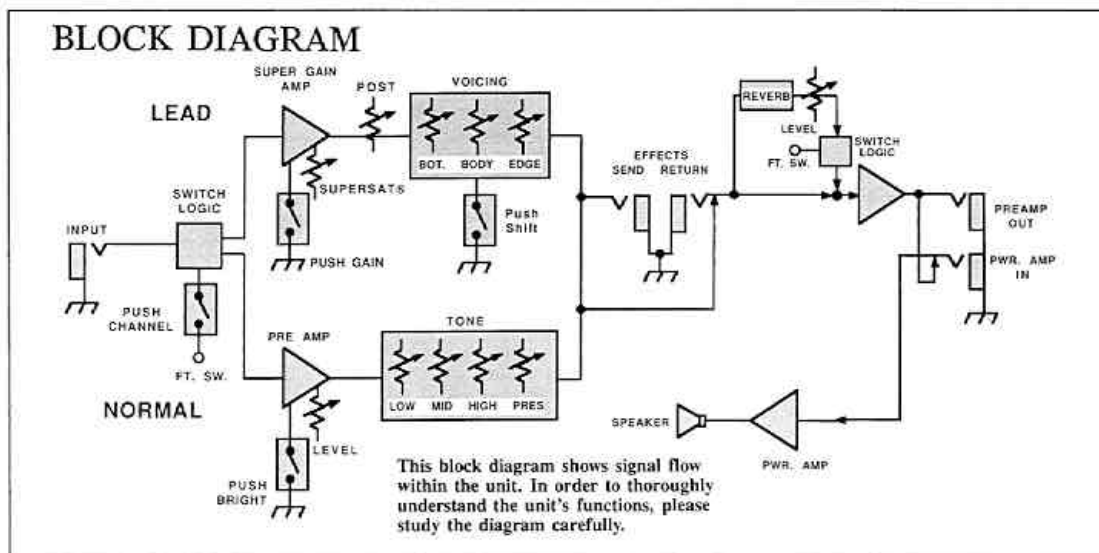

E S P A Ñ O L

Consulte los diagramas del panel delantero en la sección de inglés de este manual.

HIGH GAIN INPUT (Entrada de ganancia alta) (1)

Se usa para la mayoría de las guitarras eléctricas. Tiene 6 dB más volumen que la entrada de baja ganancia.

LOW GAIN INPUT (Entrada de baja ganancia) (2)

Se suministra para instrumentos que tienen una salida extremadamente alta, la cual puede causar la sobrecarga (distorsión) de la entrada de alta ganancia. Si se usan ambas entradas simultáneamente, el nivel de salida es el mismo (ambos son de baja ganancia).

NORMAL GAIN (Ganancia normal) (3)

Controla el nivel de volumen del canal Normal y no es afectado por los controles SuperSat o Ganancia posterior.

BRIGHT SWITCH (Interruptor de brillo) (4)

Proporciona un impulso preajustado de +6dB a las frecuencias agudas. Para activarlo, empuje el interruptor a la posición "hacia dentro".

CHANNEL SELECT SWITCH (Interruptor para selección del canal) (5)

Permite la selección del canal "lead" (solista) o normal. La posición hacia dentro selecciona el canal "lead" y la posición hacia fuera selecciona el canal normal.

LOW, MID & HIGH EQ (Ecuador de frecuencias graves, medias y agudas) (6)

Controles de tono pasivo que regulan las frecuencias graves, medias, y altas, respectivamente.

PRESENCE (ACTIVE) (Presencia [Activa]) (7)

Control de tono activo (± 15 dB) que varía la banda de frecuencias de extremos agudos. Aumenta de 0 a +15, reduce de 0 a -15.

SUPERSAT® (8)

(Fabricado bajo el Patente de los E.E.U.U. Número 4.811.401)

Una simulación con transistores de la distorsión de tubos (ligero recorte de señales). Para activar el efecto SuperSat®, debe activar el canal "lead" (solista).

SHIFT SWITCH (Interruptor de desplazamiento) (9)

Desplaza la frecuencia en que opera el control de "Cuerpo". La posición "In" permite funcionar en una frecuencia más alta al control de Cuerpo y la posición "Out" selecciona una frecuencia más baja.

GAIN SWITCH (Interruptor de ganancia) (10)

Proporciona impulso a la ganancia general del sistema. Para activarlo oprímalo a la posición "in" (hacia adentro).

POST GAIN (Control de ganancia posterior del preamplificador) (11)

Controla el volumen general del canal solista. El ajuste final de nivel debe hacerse después de que se haya obtenido el sonido deseado.

BOTTOM (Fondo) (12)

Un control activo de tono (tipo "repisa" ± 15 dB) que varía el impulso o la reducción de las frecuencias graves.

NOTA: Este control no es capaz de funcionar en el canal normal.

BODY (El conjunto) (13)

Un control activo de tono (gradual ± 15 dB) que varía el impulso o la reducción de las frecuencias medias.

NOTA: Este control no es capaz de funcionar en el canal normal.

EDGE (Extremo) (14)

Un control activo de tono (tipo “repisa” ± 15 dB) que varía el impulso o la reducción de las frecuencias agudas.

NOTA: Este control no es capaz de funcionar en el canal normal.

EFFECTS SEND (Envío de efectos) (15)

Salida para proporcionar señales a efectos exteriores de bajo nivel o a equipos procesadores de señal.

EFFECTS RETURN (Retorno de efectos) (16)

Entrada para el retorno de señales procedentes de equipos de efectos externos de bajo nivel o de procesadores de señal.

REVEL LEVEL (Nivel de “Revel”) (17)

Controla el nivel global de la reverberación.

POWER LED (LED indicador de corriente) (18)

Se ilumina cuando el amplificador recibe corriente alterna.

GROUND SWITCH (Interruptor de tierra) (19)

Un interruptor tipo balancín de tres posiciones que, en la mayoría de las aplicaciones, debe ser operado en su posición del centro o cero (0). Puede haber situaciones cuando un zumbido audible salga del altavoz. Si esta situación ocurre, ajuste la posición del interruptor de tierra a positivo o negativo (+ o -) o hasta que el ruido disminuya.

NOTA: Si el problema de ruido continúa, consulte su representante autorizado de Peavey, la fábrica de Peavey, o un técnico de servicio calificado. EL INTERRUPTOR DE TIERRA NO FUNCIONA EN LOS MODELOS DE 220/240 VOLTIOS.

POWER SWITCH (Interruptor de corriente) (20)

Oprima el interruptor a la posición “hacia dentro” (encendido). La luz roja del piloto (indicador) se encenderá indicando que la unidad está recibiendo corriente alterna.

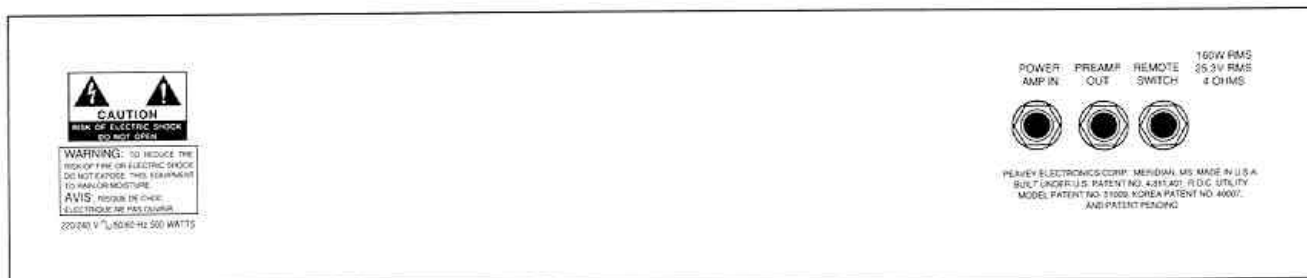

POWER AMP INPUT (Entrada del amplificador de potencia) (21)

Se usa para conectar la señal del nivel de línea al amplificador de potencia.

PREAMP OUT (Salida de preamplificador) (22)

La salida del preamplificador puede usarse para mandar la señal a una consola de mezcla, grabadora, etc. Conecte la salida del preamplificador, utilizando un cable blindado, a una entrada de la grabadora, mezclador, etc. Esta interconexión no afecta la operación del amplificador.

REMOTE SWITCH JACK (Enchufe hembra de interruptor remoto) (23)

Se suministra para la conexión del pedal interruptor de control remoto que se suministra. El pedal interruptor se utiliza para seleccionar los canales solista o normal y desactivar la reverberación. Cuando se utilice el pedal de control remoto, inserte siempre la clavija completamente (segundo retén) para asegurar el correcto funcionamiento.

LINE CORD (120 V PRODUCTS ONLY) (Cable de corriente para 120 v solamente) (24)

Para su protección hemos incorporado un cable de 3 polos con polo a tierra. No es recomendable remover la pata del polo a tierra bajo ninguna circunstancia, se recomienda un adaptador en caso necesario. Esto reducirá ruidos y peligrosos corrientazos.

FRANCAIS

**Veillez vous référer au “front panel line art”
situé dans la section en langue anglaise de ce manuel.**

HIGH GAIN INPUT (Entrée haut gain) (1)

Cette prise s'utilise avec la plupart des guitares électriques. Elle donne un gain supérieur de 6dB à l'entrée “Low Gain”.

LOW GAIN INPUT (Entrée faible Gain) (2)

Cette prise accepte les instruments à très haut niveau de sortie qui causeraient de la saturation (distorsion) sur l'entrée “High Gain”. Si les deux entrées sont utilisées simultanément, les niveaux sont alors équivalents (“Low Gain”).

NORMAL GAIN (Gain normal) (3)

Contrôle le niveau de volume du canal “Normal” et n'est pas affecté par les commandes “SuperSat” ou “Post Gain”.

BRIGHT SWITCH (Sélecteur de brillance) (4)

Accentue (6db) les fréquences aigües. Pour activer, mettre le bouton en position “In”.

CHANNEL SELECT SWITCH (Sélecteur de canal) (5)

Permet de sélectionner les canaux “Lead” ou “Normal”. La position “In” du sélecteur correspond au canal “Normal”. La position “Out” sélectionne le canal “Lead”.

LOW, MID, & HIGH EQ (Égalisation graves, moyennes et aiguës) (6)

Réglages de tonalité passifs réglant respectivement les fréquences graves, moyennes et aiguës.

PRESENCE (ACTIVE) (Présence (actif)) (7)

Réglage de tonalité actif (± 15 dB) affectant les fréquences très aiguës. 0 à +15 renforce (amplifie), 0 à -15 coupe (réduit).

SUPERSAT[®] (Sélecteur SuperSat[®]) (8)

Simulation par transistor de distorsion à tube (saturation douce). Afin de pouvoir utiliser l'effet “SuperSat”, le canal “Lead” doit être activé via la télécommande au pied.

SHIFT SWITCH (Commutateur de décalage) (9)

Change la fréquence à laquelle la commande “Body” agit. La position “In” permet à la commande “Body” d'agir à une fréquence plus aiguë et la position “Out” sélectionne une fréquence plus grave.

GAIN SWITCH (Interrupteur de gain) (10)

Hausse le gain global du système. Abaisser à la position “In” pour activer.

POST GAIN (11)

Commande le volume général du canal “Lead”. Le réglage final de niveau doit être effectué après avoir obtenu la sonorité désirée à l'aide des autres réglages.

BOTTOM (Graves) (12)

Réglage de tonalité actif (type passe bas, ± 15 dB) faisant varier la coupure ou l'amplification des fréquences graves.

NOTE: Cette commande ne fonctionne pas sur le canal “Normal”.

BODY (corps) (13)

Bouton de réglage de tonalité actif (correction ± 15 dB) faisant varier la coupure ou l'amplification des fréquences moyennes.

NOTE: Cette commande ne fonctionne pas sur le canal "Normal".

EDGE (Aigus) (14)

Bouton de réglage de tonalité actif (type passe haut, ± 15 dB) faisant varier la coupure ou l'amplification des hautes fréquences.

NOTE: Cette commande ne fonctionne pas sur le canal "Normal".

EFFECTS SEND (Envoi d'effets) (15)

Prise de sortie servant à fournir des signaux à des appareils externes de traitement de signal ou d'effets à bas niveau.

EFFETCS RETURN (Retour d'effets) (16)

Prise d'entrée pour signaux provenant d'appareils externes de traitement de signal ou d'effets à bas niveau.

REVERB LEVEL (Niveau de réverbération) (17)

Contrôle le niveau de réverbération global.

POWER LED (DEL témoin de mise sous tension) (18)

S'allume lorsque l'ampli reçoit l'alimentation CA.

GROUND SWITCH (Sélecteur de mise à terre) (19)

Commutateur rotatif à trois positions devant, la plupart du temps, être en position centrale (zéro). Dans certaines situations un bruit de ronflement ou un bourdonnement audible peut provenir des haut-parleurs de puissance. Dans ce cas, bougez le sélecteur de mise à terre jusqu'en position positive ou négative (+ ou -) ou jusqu'à ce que le bruit diminue.

NOTE: Si le problème de bruit persiste, consultez votre détaillant autorisé Peavey, la fabrique Peavey, ou un technicien de service qualifié. LE SÉLECTEUR DE MISE À TERRE NE FONCTIONNE PAS SUR LES APPAREILS 220/240 VOLT.

POWER SWITCH (Interrupteur d'alimentation) (20)

Mettre l'interrupteur en position "On". La lampe témoin rouge (DEL) s'illumine indiquant que l'appareil est alimenté en courant.

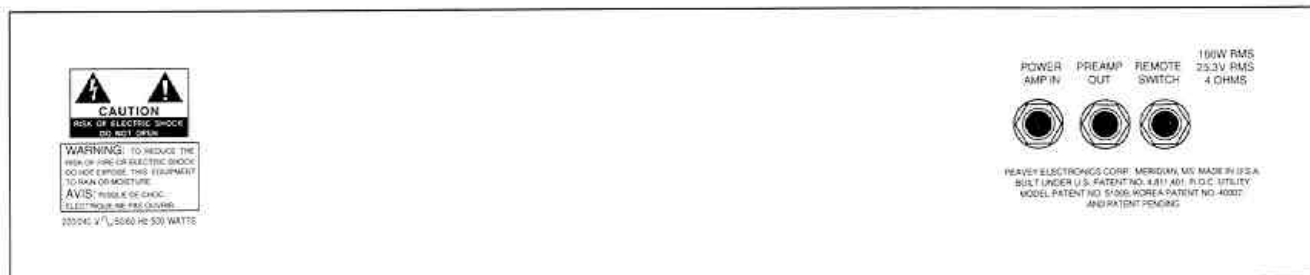

POWER AMP INPUT (Entrée ampli de puissance) (21)

Sert à brancher un signal de niveau ligne à l'amplificateur de puissance.

PREAMP OUT (Sortie préampli) (22)

La sortie préampli peut être utilisée pour amener le signal à une table de mixage, un magnétophone, etc. Utilisez des câbles blindés pour brancher la sortie du préampli à l'entrée d'un magnétophone, d'un mélangeur, etc. Ce branchement n'affecte pas le fonctionnement de l'amplificateur.

REMOTE SWITCH JACK (Prise pour interrupteur à distance) (23)

Permet de brancher la pédale-interrupteur incluse. L'interrupteur au pied est utilisé pour sélectionner les canaux "Normal" ou "Lead" et pour mettre hors circuit la réverbération. Afin d'assurer un bon fonctionnement lors de l'utilisation de l'interrupteur au pied, insérez la fiche bien à fond (au second clic).

LINE CORD (120V products only) (Cordon d'alimentation pour appareils 120V seulement) (24)

Pour votre sécurité, nous avons incorporé un câble d'alimentation secteur à 3 fils avec mise-à-terre appropriée. Il n'est pas recommandé d'enlever la broche de mise-à-terre en aucune circonstance. S'il est nécessaire d'utiliser l'équipement sans mise-à-terre appropriée, utilisez des adaptateurs de mise-à-terre convenables. Une bonne mise-à-terre amoindrit le bruit de fond et réduit grandement les risques de choc.

DEUTSCH

Siehe diagramm der frontplatte im englischen teil des handbuchs.

HIGH GAIN INPUT (1)

Dieser Eingang kann für die meisten elektrischen Gitarren verwendet werden. Er ist 6 dB empfindlicher als der Low Gain Input.

LOW GAIN INPUT (2)

Dieser Eingang ist für die Instrumente vorgesehen, die ein besonders hohes Ausgangssignal erzeugen. Falls beide Eingänge gleichzeitig benutzt werden, sind die Ausgangssignale gleich (beide sind dann Low Gain).

NORMAL GAIN (3)

Regelt den Pegel des Normal Kanals und wird nicht von den SuperSat oder Post Gain Reglern beeinflusst.

BRIGHT SWITCH (4)

Besorgt einen voreingestellten Schub (+6dB) in den hohen Frequenzen. Zur Aktivierung den Knopf in die "In"-Position drücken.

CHANNEL SELECT SWITCH (5)

Erlaubt die Auswahl des Lead- oder des Normal-Kanals. Die "In"-Position des Schalters wählt den Lead-Kanal, die "Out"-Position den Normal-Kanal an.

LOW, MID & HIGH EQ (6)

Hierbei handelt es sich um passive Klangregler, die tiefe, mittlere und hohe Frequenzen entsprechend regeln.

PRESENCE (ACTIVE) (7)

Eine aktive Klangregelung (± 15 dB) zur Beeinflussung des höchsten Frequenzbereichs. 0 bis +15 dB entspricht einer Anhebung, 0 bis -15 dB einer Absenkung.

SUPERSAT (8)

Eine transistorsimulierte Röhrenverzerrung (sanftes Übersteuern). Um den SuperSat-Effekt zu aktivieren, muß der Lead-Kanal eingeschaltet sein.

SHIFT SWITCH (9)

Verlagert die Frequenz des Body-Reglers. In der "In"-Position arbeitet der Regler in hohen Frequenzen, die "Out"-Position wählt tiefere Frequenzen an.

GAIN SWITCH (10)

Boostet die Gesamtlautstärke. Zum Einschalten auf die "In"- Position bringen.

POST GAIN (11)

Kontrolliert den gesamten Lautstärke-pegel des Hauptkanals (Mastervolumen). Die endgültige Lautstärkeregelung sollte vorgenommen werden, nachdem der gewünschte Sound eingestellt ist.

BOTTOM (12)

Eine aktive Tonkontrolle (± 15 dB), die die Low Frequenz boostet oder abschneidet.

MERKE: Diese Funktion arbeitet nicht auf dem Normal Kanal.

BODY (13)

Ein aktiver Klangregler (Spitzenwert/Mittenrastung, ± 15 dB) der die Mittenfrequenzen anhebt oder absenkt.

MERKE: Dieser Funktion arbeitet nicht auf dem Normal Kanal.

EDGE (14)

Eine aktive Tonkontrolle (± 15 dB), die die High Frequenz boostet oder abschneidet.

MERKE: Diese Funktion arbeitet nicht auf dem Normal-Kanal.

EFFECTS SEND (15)

Ausgang für Zuliefersignale zu externen niederohmigen Effekten oder Signal-Prozessoren.

EFFECTS RETURN (16)

Eingang für rückführende Signale von niederohmigen Effekten oder Signal-Prozessoren.

REVEL LEVEL (17)

Regelt den Reverb-Pegel.

POWER LED (18)

Zeigt die eingeschaltete Netzspannung an.

GROUND SWITCH (19)

Der Ground-Schalter funktioniert nicht bei den 220/240 Volt-Modellen.

POWER SWITCH (Netzschalter) (20)

Bringen Sie den Schalter auf die ON-Position. Die rote Kontrollampe (LED) leuchtet und zeigt an, daß das Gerät eingeschaltet ist.

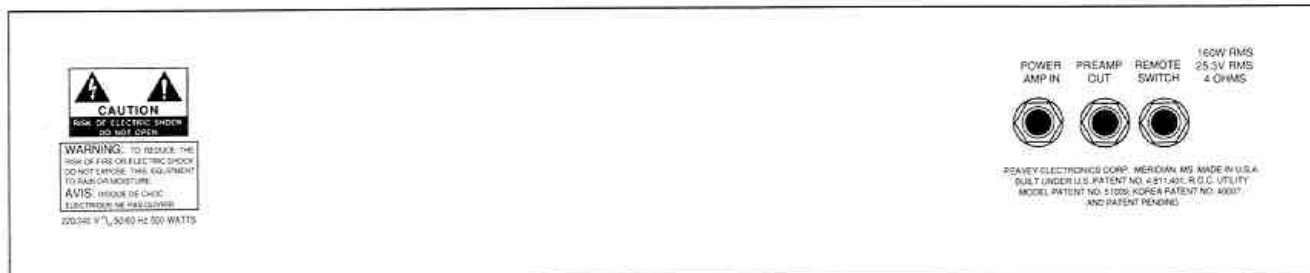

POWER AMP INPUT (21)

Vorgesehen für den Anschluß eines Line-Signals an den Endverstärker.

PREAMP OUT (Vorstufenausgang) (22)

Dieser Ausgang kann zum Anschluß des Verstärkers an einen Mixer, eine Bandmaschine, etc. verwendet werden. Verbinden Sie den Ausgang mit Hilfe eines abgeschirmten Kabels mit dem Eingang des entsprechenden Gerätes. Dieser Anschluß beeinflusst die Funktionen des Verstärkers nicht.

REMOTE SWITCH JACK (23)

Sorgt für die Verbindung des mitgelieferten Fernbedienungs-Fußschalters. Der Fußschalter wird verwendet, um zwischen den beiden Eingangskanälen zu wählen und um den Hall zu schalten. Beim Anschluß des Fußschalters muß der Stecker völlig eingesteckt sein (zweimal Klicken), um die richtige Funktion zu gewährleisten.

LINE CORD (120V products only) (Nur bei 120 Volt-Geräten) (24)

Zu Ihrer Sicherheit haben wir das Gerät mit einem dreiadrigen geerdeten Netzkabel versehen. Es ist unter keinen Umständen empfehlenswert den Erdungskontakt des Anschlußkabels zu lösen. Falls es notwendig sein sollte, das Equipment ohne die vorgesehene Erdung zu betreiben empfiehlt sich die Verwendung eines Grounding Adaptors. Die geringsten Störgeräusche und die höchste Sicherheit vor elektrischen Schlägen wird jedoch durch die Benutzung der vorgesehenen Erdungsmöglichkeiten erreicht.

THIS LIMITED WARRANTY VALID ONLY WHEN PURCHASED AND REGISTERED IN THE UNITED STATES OR CANADA. ALL EXPORTED PRODUCTS ARE SUBJECT TO WARRANTY AND SERVICES TO BE SPECIFIED AND PROVIDED BY THE AUTHORIZED DISTRIBUTOR FOR EACH COUNTRY.

Ces clauses de garantie ne sont valables qu'aux Etats-Unis et au Canada. Dans tous les autres pays, les clauses de garantie et de maintenance sont fixées par le distributeur national et assurées par lui selon la législation en vigueur.

Diese Garantie ist nur in den USA und Kanada gültig. Alle Export-Produkte sind der Garantie und dem Service des Importeurs des jeweiligen Landes unterworfen. Esta garantía es válida solamente cuando el producto es comprado en E.U. continentales o en Canada. Todos los productos que sean comprados en el extranjero, están sujetos a las garantías y servicio que cada distribuidor autorizado determine y ofrezca en los diferentes países.

PEAVEY ONE-YEAR LIMITED WARRANTY/REMEDY

PEAVEY ELECTRONICS CORPORATION ("PEAVEY") warrants this product, EXCEPT for covers, footswitches, patchcords, tubes and meters, to be free from defects in material and workmanship for a period of one (1) year from date of purchase, PROVIDED, however, that this limited warranty is extended only to the original retail purchaser and is subject to the conditions, exclusions, and limitations hereinafter set forth:

PEAVEY 90-DAY LIMITED WARRANTY ON TUBES AND METERS

If this product contains tubes or meters, Peavey warrants the tubes or meters contained in the product to be free from defects in material and workmanship for a period of ninety (90) days from date of purchase; PROVIDED, however, that this limited warranty is extended only to the original retail purchaser and is also subject to the conditions, exclusions, and limitations hereinafter set forth.

CONDITIONS, EXCLUSIONS, AND LIMITATIONS OF LIMITED WARRANTIES

These limited warranties shall be void and of no effect, if:

- a. The first purchase of the product is for the purpose of resale; or
- b. The original retail purchase is not made from an AUTHORIZED PEAVEY DEALER; or
- c. The product has been damaged by accident or unreasonable use, neglect, improper service or maintenance, or other causes not arising out of defects in material or workmanship; or
- d. The serial number affixed to the product is altered, defaced, or removed.

In the event of a defect in material and/or workmanship covered by this limited warranty, Peavey will:

- a. In the case of tubes or meters, replace the defective component without charge.
- b. In other covered cases (i.e., cases involving anything other than covers, footswitches, patchcords, tubes or meters), repair the defect in material or workmanship or replace the product, at Peavey's option; and provided, however, that, in any case, all costs of shipping, if necessary, are paid by you, the purchaser.

THE WARRANTY REGISTRATION CARD SHOULD BE ACCURATELY COMPLETED AND MAILED TO AND RECEIVED BY PEAVEY WITHIN FOURTEEN (14) DAYS FROM THE DATE OF YOUR PURCHASE.

In order to obtain service under these warranties, you must:

- a. Bring the defective item to any PEAVEY AUTHORIZED DEALER or AUTHORIZED PEAVEY SERVICE CENTER and present therewith the ORIGINAL PROOF OF PURCHASE supplied to you by the AUTHORIZED PEAVEY DEALER in connection with your purchase from him of this product. If the DEALER or SERVICE CENTER is unable to provide the necessary warranty service you will be directed to the nearest other PEAVEY AUTHORIZED DEALER or AUTHORIZED PEAVEY SERVICE CENTER which can provide such service.

OR

- b. Ship the defective item, prepaid, to:

PEAVEY ELECTRONICS CORPORATION
International Service Center
326 Hwy. 11 & 80 East
MERIDIAN, MS 39301

including therewith a complete, detailed description of the problem, together with a legible copy of the original PROOF OF PURCHASE and a complete return address. Upon Peavey's receipt of these items:

If the defect is remedial under these limited warranties and the other terms and conditions expressed herein have been complied with, Peavey will provide the necessary warranty service to repair or replace the product and will return it, FREIGHT COLLECT, to you, the purchaser.

Peavey's liability to the purchaser for damages from any cause whatsoever and regardless of the form of action, including negligence, is limited to the actual damages up to the greater of \$500.00 or an amount equal to the purchase price of the product that caused the damage or that is the subject of or is directly related to the cause of action. Such purchase price will be that in effect for the specific product when the cause of action arose. This limitation of liability will not apply to claims for personal injury or damage to real property or tangible personal property allegedly caused by Peavey's negligence. Peavey does not assume liability for personal injury or property damage arising out of or caused by a non-Peavey alteration or attachment, nor does Peavey assume any responsibility for damage to interconnected non-Peavey equipment that may result from the normal functioning and maintenance of the Peavey equipment.

UNDER NO CIRCUMSTANCES WILL PEAVEY BE LIABLE FOR ANY LOST PROFITS, LOST SAVINGS, ANY INCIDENTAL DAMAGES, OR ANY CONSEQUENTIAL DAMAGES ARISING OUT OF THE USE OR INABILITY TO USE THE PRODUCT, EVEN IF PEAVEY HAS BEEN ADVISED OF THE POSSIBILITY OF SUCH DAMAGES.

THESE LIMITED WARRANTIES ARE IN LIEU OF ANY AND ALL WARRANTIES, EXPRESSED OR IMPLIED, INCLUDING, BUT NOT LIMITED TO, THE IMPLIED WARRANTIES OF MERCHANTABILITY AND FITNESS FOR A PARTICULAR USE; PROVIDED, HOWEVER, THAT IF THE OTHER TERMS AND CONDITIONS NECESSARY TO THE EXISTENCE OF THE EXPRESSED, LIMITED WARRANTIES, AS HEREINABOVE STATED, HAVE BEEN COMPLIED WITH, IMPLIED WARRANTIES ARE NOT DISCLAIMED DURING THE APPLICABLE ONE-YEAR OR NINETY-DAY PERIOD FROM DATE OF PURCHASE OF THIS PRODUCT.

SOME STATES DO NOT ALLOW LIMITATION ON HOW LONG AN IMPLIED WARRANTY LASTS, OR THE EXCLUSION OR LIMITATION OF INCIDENTAL OR CONSEQUENTIAL DAMAGES, SO THE ABOVE LIMITATIONS OR EXCLUSIONS MAY NOT APPLY TO YOU. THESE LIMITED WARRANTIES GIVE YOU SPECIFIC LEGAL RIGHTS, AND YOU MAY ALSO HAVE OTHER RIGHTS WHICH MAY VARY FROM STATE TO STATE.

THESE LIMITED WARRANTIES ARE THE ONLY EXPRESSED WARRANTIES ON THIS PRODUCT, AND NO OTHER STATEMENT, REPRESENTATION, WARRANTY, OR AGREEMENT BY ANY PERSON SHALL BE VALID OR BINDING UPON PEAVEY.

In the event of any modification or disclaimer of expressed or implied warranties, or any limitation of remedies, contained herein conflicts with applicable law, then such modification, disclaimer or limitation, as the case may be, shall be deemed to be modified to the extent necessary to comply with such law.

Your remedies for breach of these warranties are limited to those remedies provided herein and Peavey Electronics Corporation gives this limited warranty only with respect to equipment purchased in the United States of America.

INSTRUCTIONS — WARRANTY REGISTRATION CARD

1. Mail the completed WARRANTY REGISTRATION CARD to:

PEAVEY ELECTRONICS CORPORATION
POST OFFICE BOX 2898
MERIDIAN, MISSISSIPPI 39302-2898

- a. Keep the PROOF OF PURCHASE. In the event warranty service is required during the warranty period, you will need this document. There will be no identification card issued by Peavey Electronics Corporation.
2. IMPORTANCE OF WARRANTY REGISTRATION CARDS AND NOTIFICATION OF CHANGES OF ADDRESSES:
 - a. Completion and mailing of WARRANTY REGISTRATION CARDS — Should notification become necessary for any condition that may require correction, the REGISTRATION CARD will help ensure that you are contacted and properly notified.
 - b. Notice of address changes — If you move from the address shown on the WARRANTY REGISTRATION CARD, you should notify Peavey of the change of address so as to facilitate your receipt of any bulletins or other forms of notification which may become necessary in connection with any condition that may require dissemination of information or correction.
3. You may contact Peavey directly by telephoning (601) 483-5365.

IMPORTANT SAFETY INSTRUCTIONS

WARNING: When using electric products, basic cautions should always be followed, including the following.

1. Read all safety and operating instructions before using this product.
2. All safety and operating instructions should be retained for future reference.
3. Obey all cautions in the operating instructions and on the back of the unit.
4. All operating instructions should be followed.
5. This product should not be used near water, i.e., a bathtub, sink, swimming pool, wet basement, etc.
6. This product should be located so that its position does not interfere with its proper ventilation. It should not be placed flat against a wall or placed in a built-in enclosure that will impede the flow of cooling air.
7. This product should not be placed near a source of heat such as a stove, radiator, or another heat producing amplifier.
8. Connect only to a power supply of the type marked on the unit adjacent to the power supply cord.
9. Never break off the ground pin on the power supply cord. For more information on grounding, write for our free booklet "Shock Hazard and Grounding."
10. Power supply cords should always be handled carefully. Never walk or place equipment on power supply cords. Periodically check cords for cuts or signs of stress, especially at the plug and the point where the cord exits the unit.
11. The power supply cord should be unplugged when the unit is to be unused for long periods of time.
12. If this product is to be mounted in an equipment rack, rear support should be provided.
13. Metal parts can be cleaned with a damp rag. The vinyl covering used on some units can be cleaned with a damp rag or an ammonia-based household cleaner if necessary. Disconnect unit from power supply before cleaning.
14. Care should be taken so that objects do not fall and liquids are not spilled into the unit through the ventilation holes or any other openings.
15. This unit should be checked by a qualified service technician if:
 - a. The power supply cord or plug has been damaged.
 - b. Anything has fallen or been spilled into the unit.
 - c. The unit does not operate correctly.
 - d. The unit has been dropped or the enclosure damaged.
16. The user should not attempt to service this equipment. All service work should be done by a qualified service technician.
17. This product should be used only with a cart or stand that is recommended by Peavey Electronics.
18. Exposure to extremely high noise levels may cause a permanent hearing loss. Individuals vary considerably in susceptibility to noise induced hearing loss, but nearly everyone will lose some hearing if exposed to sufficiently intense noise for a sufficient time. The U.S. Government's Occupational Safety and Health Administration (OSHA) has specified the following permissible noise level exposures.

Duration Per Day In Hours	Sound Level dBA, Slow Response
8	90
6	92
4	95
3	97
2	100
1 1/2	102
1	105
1/2	110
1/4 or less	115

According to OSHA, any exposure in excess of the above permissible limits could result in some hearing loss.

Ear plugs or protectors in the ear canals or over the ears must be worn when operating this amplification system in order to prevent a permanent hearing loss if exposure is in excess of the limits as set forth above. To ensure against potentially dangerous exposure to high sound pressure levels, it is recommended that all persons exposed to equipment capable of producing high sound pressure levels such as this amplification system be protected by hearing protectors while this unit is in operation.

SAVE THESE INSTRUCTIONS!



Features and specifications subject to change without notice.