

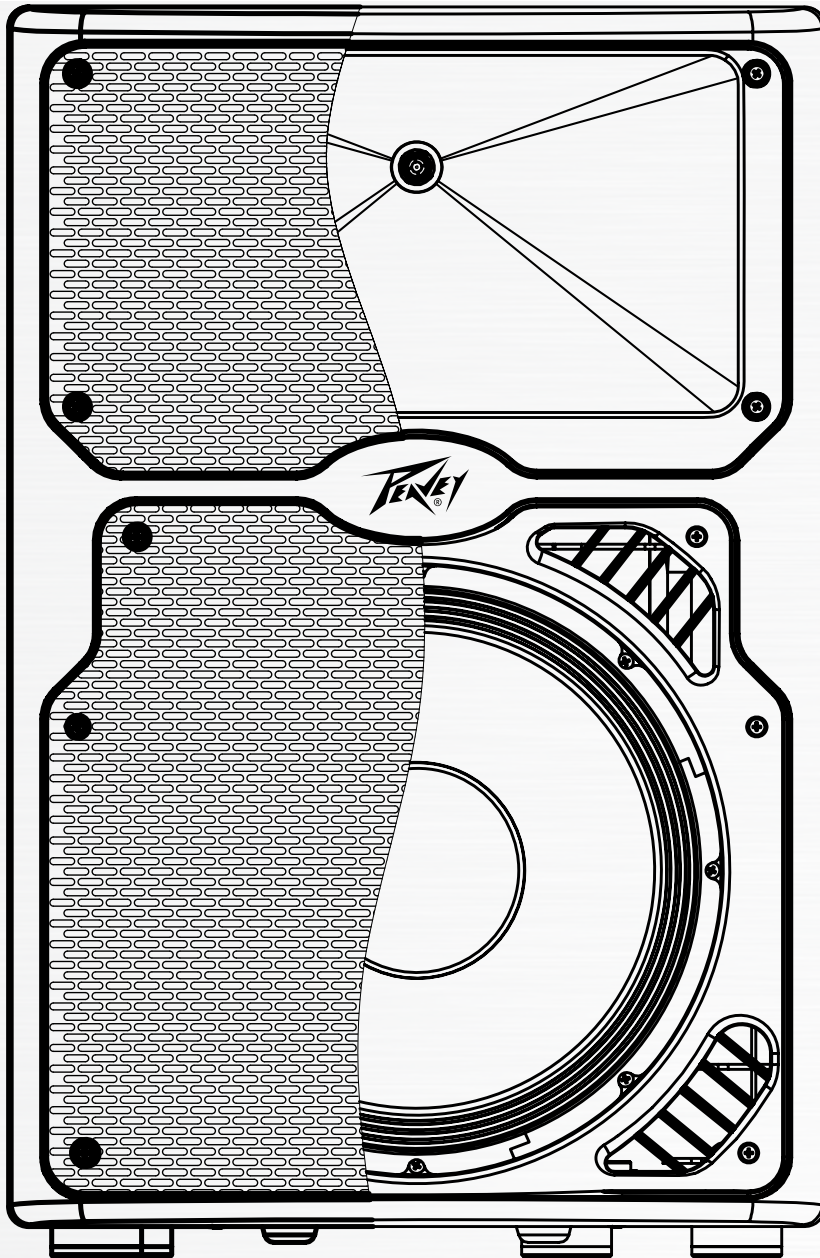

PVXp™ 10 Bluetooth® Powered Speaker System

Operating
Manual





FCC/ICES Compliancy Statement

This device complies with Part 15 of the FCC. Operation is subject to the following two conditions: (1) this device may not cause harmful interference, and (2) this device must accept any interference received, that may cause undesired operation.

Le présent appareil est conforme aux CNR d'Industrie Canada applicables aux appareils radio exempts de licence. L'exploitation est autorisée aux deux conditions suivantes: (1) l'appareil ne doit pas produire de brouillage, et (2) l'utilisateur de l'appareil doit accepter tout brouillage radioélectrique subi, même si le brouillage est susceptible d'en compromettre le fonctionnement.

Warning: Changes or modifications to the equipment not approved by Peavey Electronics Corp. can void the user's authority to use the equipment.

Note – This equipment has been tested and found to comply with the limits for a Class A digital device, pursuant to Part 15 of the FCC rules. These limits are designed to provide reasonable protection against harmful interference when the equipment is operated in a commercial environment. This equipment generates, uses and can radiate radio frequency energy and, if not installed and used in accordance with the instruction manual, may cause harmful interference to radio communications. Operation of this equipment in a residential area is likely to cause harmful interference in which case the user will be required to correct the interference at their expense.



Peavey Electronics Corporation • 5022 Hartley Peavey Drive • Meridian, MS • 39305
(601) 483-5365 • FAX (601) 486-1278 • www.peavey.com • 80305780 • ©2011

ENGLISH

Introduction

Thank you for purchasing the powered Peavey® PVX™p 10 Bluetooth® speaker system. The PVX™p 10 Bluetooth® features an reliable bi-amped power section that provides a total of 520 Watts of peak dynamic power with DSP based compression and limiting. Featuring a 10” heavy-duty woofer with a 2 3/8 inch voice coil and 50 ounce magnet, and the RX™10 compression driver with a 1 inch titanium diaphragm on a 100 degree horizontal x 60 degree vertical pattern asymmetrical horn. The PVX™p 10 Bluetooth® provides two channels with a balanced input via a combination jack that accepts balanced TRS 1/4 inch input as well as a balanced XLR input. A switch is provided to change between line level gain and mic level gain. A third channel is for a Bluetooth® source, or alternatively a 1/8” AUX input jack. Each channel has an adjustable Level control, and a three-band EQ section. There is a balanced output, a Male XLR, that can feed the mixed signals from the three channels out to another component. A front baffle LED indicator that can be set to light when power is on, and when the “soft-limiting” DDT circuit is activated, or turned off altogether. The LCD display and EQ presets, along with other DSP operating parameters are accessed via a one-knob selector.

Features

- * Two-way bi-amped sound reinforcement enclosure
- * 10” heavy-duty woofer with 2 3/8” voice coil & 50 oz. magnet
- * RX™10 compression driver, with 1 inch titanium diaphragm
- * Reliable fan-cooled power amps with DSP protection
- * Total of 520W peak dynamic power
- * DSP control for precise crossover, EQ and limiting functions
- * DSP I/O is at 48 kHz and 24 bits, internal processing is 56 bit double-precision
- * Peavey’s Quadratic Throat Waveguide™ technology, 100 by 60 degree coverage
- * Asymmetrical horn aims the sound down 10 degrees, at the audience, not over their heads
- * Bluetooth® input is via a dedicated input channel
- * Analog input is via a combo female XLR and 1/4” TRS phone jack with balanced input
- * Three channels in total, two for analog, and one for Bluetooth or AUX input via a 1/8” jack
- * Each channel has a level control and a 3-band EQ section to adjust and shape the input signals
- * Mix/Thru Output is via a male XLR jack
- * Durable plastic injection-molded trapezoidal enclosure
- * Extra angled section on right side allows floor monitor use
- * Full-coverage heavy-duty perforated steel grilles, with powder coat finish
- * Pole mount molded-in for 1 3/8” diameter poles
- * Top and bottom flying point inserts

Description

The PVX™p 10 Bluetooth® is a two-way sound reinforcement system based on a heavy-duty Pro 10 10” woofer and a RX™10 titanium diaphragm dynamic compression driver mounted on a 100 by 60 degree coverage Quadratic Throat Waveguide™. It’s sleek, modern appearance coupled with excellent performance, offer a superb overall package.

The lightweight yet rugged injection-molded plastic enclosure with molded-in stand mount cup facilitates portable use for live music or PA sound. The trapezoidal cabinet has two handles for ease of portability, and an extra 45-degree angled section on the right side to allow use as a floor monitor. Four sets of flying/mounting

points, two sets on the top, two sets on the bottom, and one single insert on the rear near the bottom, with a total of 13 cabinet inserts, provide for the ultimate in installation flexibility. A pair of black powder coated perforated steel grilles provides driver protection and a professional appearance.

The heavy-duty 10" woofer has a 2 3/8" voice coil diameter, and a 50 oz. magnet for chest-pounding bass. The RX™ 10 compression driver tweeter is coupled to a Quadratic Throat™ constant directivity waveguide. The Quadratic Throat Waveguide™ is an original Peavey® design, with smooth, even response, low distortion and good high frequency dispersion. This horn has an asymmetrical vertical polar response, aiming the main energy lobe down 10 degrees, so it is aimed at the audience, instead of over their heads. The vertical polar pattern is +20 degrees, -40 degrees. This helps reduce ceiling reflections for greater clarity and gain before feedback.

The PVX™ p 10 Bluetooth® speaker system power amplifiers providing the bi-amplification are low-distortion reliable fan-cooled units providing a total of 520W peak dynamic power for the system.

There is 400W peak dynamic power for the woofer, and 120W peak dynamic power for the tweeter. The power supply for both amps is a switch mode type for low weight and high efficiency. Both amplifiers feature sophisticated DSP based signal compression, which virtually eliminates audible power amplifier clipping. Cooling is provided via a low-noise fan, for reliable operation under any conditions.

Input for two of the three input channels is via a combo female XLR and 1/4" TRS phone jack with balanced input to the preamp/EQ electronics, and a level control. For these two channels, a switch is provided to change between line level gain and mic level gain. A third channel is for a Bluetooth® source, or alternatively a 1/8" AUX input jack. Each channel has an adjustable Level control knob, and also a three-band EQ section that is accessible via the DSP menu Push knob. There is a balanced output, a Male XLR, that can feed the mixed signals from the three channels out to another component. This output allows linking of additional speaker systems, or feed of the signal to a powered subwoofer, etc.

The cabinet of the PVX™ p 10 Bluetooth® speaker system has multiple mounting fly points, providing outstanding versatility in permanent install use. A pair of widely spaced M8 inserts is molded-in on the top, and a pair on the bottom, and a set of four M8 inserts is available on the top, on the bottom for use with the Versamount™ 70, and one M8 on the rear near the bottom. This is a total of 13 mounting inserts in all. All of these inserts have retaining hardware on the inside of the plastic cabinet, providing a more reliable and safe mode of mounting the cabinet.

Applications

The Peavey PVX™ p 10 Bluetooth® has a variety of applications such as sound reinforcement, public address, side fill system, karaoke or musical playback.

The multiple fly points make use as a permanent install system very convenient with lots of installation flexibility. A typical signal source for the line-level inputs of the Peavey PVX™ p 10 Bluetooth® would be a sound reinforcement mixing console (mixer) or the output from a CD player, MP3 player or tape deck. The Bluetooth® link provides for many modern devices to link to the system, such as smart phones, digital mixers, etc. A typical dynamic microphone can be connected directly via the XLR input and used as well.

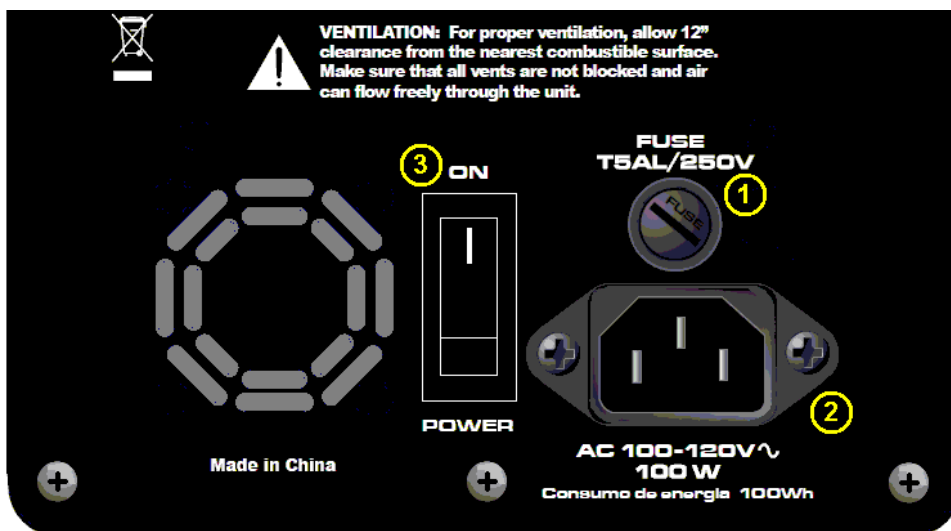

FUSE (1)

⚡ The unit is AC power line fuse protected from overloads and fault conditions with a slow-blow 5 x 20mm 250V fuse. This fuse is located within the cap of the fuse enclosure just above the IEC power cord connection. If the fuse fails, **THE FUSE MUST BE REPLACED WITH THE SAME TYPE AND VALUE IN ORDER TO AVOID DAMAGE TO THE EQUIPMENT AND TO PREVENT VOIDING THE WARRANTY!**

The fuse in the PVX™ p 10 Bluetooth® can be replaced with a time-delay type 5 x 20 mm size 250V rated fuse.

For 100-120VAC operation, a fuse rated at 5 amps should be used. In the USA, types GDC, GMC, 215, 218, and 477 cartridge-style 5 x 20 mm size fuses with a 5 amp 250V rating can be used. The fuse should conform to the international fuse classification “T5AL”.

For the Export model, using an input power voltage range of from 220VAC to 240VAC, use a 2.5 amp rated, 250V 5 x 20 mm cartridge type time-delay fuse, which conforms to the international fuse classification “T2.5AL”.

If the unit continues to blow replacement fuses, do not keep replacing them- it should be taken to a qualified service center for repair.

To replace the fuse, be sure to remove the IEC power cord from the IEC socket (2).

Remove the cap to the fuse enclosure (1) using a flat blade screwdriver tip inserted into the fuse cap slot. Push the cap in and turn the cap CCW and unscrew the cap out until it comes free from the rear portion of the holder. The blown fuse should come out with the cap.

Remove the blown fuse and replace it with the proper type per instructions previously supplied. Then, once the new fuse has been put in place, re-insert the fuse enclosure cap, push in and screw the cap in CW, and make sure it is fully seated.

Before re-attaching the IEC power cord to the IEC socket, make sure the Power switch is in the OFF position, so that intermittent contact of the IEC cord while it is being connected will not unduly stress the amplifier or the fuse.

Now re-attach the IEC power cord, and you can then use the Power switch (3) to turn the unit on.

IEC POWER CORD CONNECTION (2)

 This receptacle is for the IEC line cord (supplied) that provides AC power to the unit. It is very important that you ensure the PVX™p 10 Bluetooth® has the proper AC line voltage supplied. You can find the proper voltage for your PVX™p 10 Bluetooth® printed next to the IEC line (power) cord on the rear panel of the unit.

Please read this guide carefully to ensure your personal safety as well as the safety of your equipment. Never break off the ground pin on any equipment. It is provided for your safety. If the outlet used does not have a ground pin, a suitable grounding adapter should be used and the third wire should be grounded properly. To prevent the risk of shock or fire hazard, always be sure that the mixer and all other associated equipment are properly grounded.

ON-OFF SWITCH (3)

This rocker switch supplies AC power to the PVX™p 10 Bluetooth® when switched to the ON position. The ON position is with the top side of the switch pushed “in” or nearly flush with the rear panel.

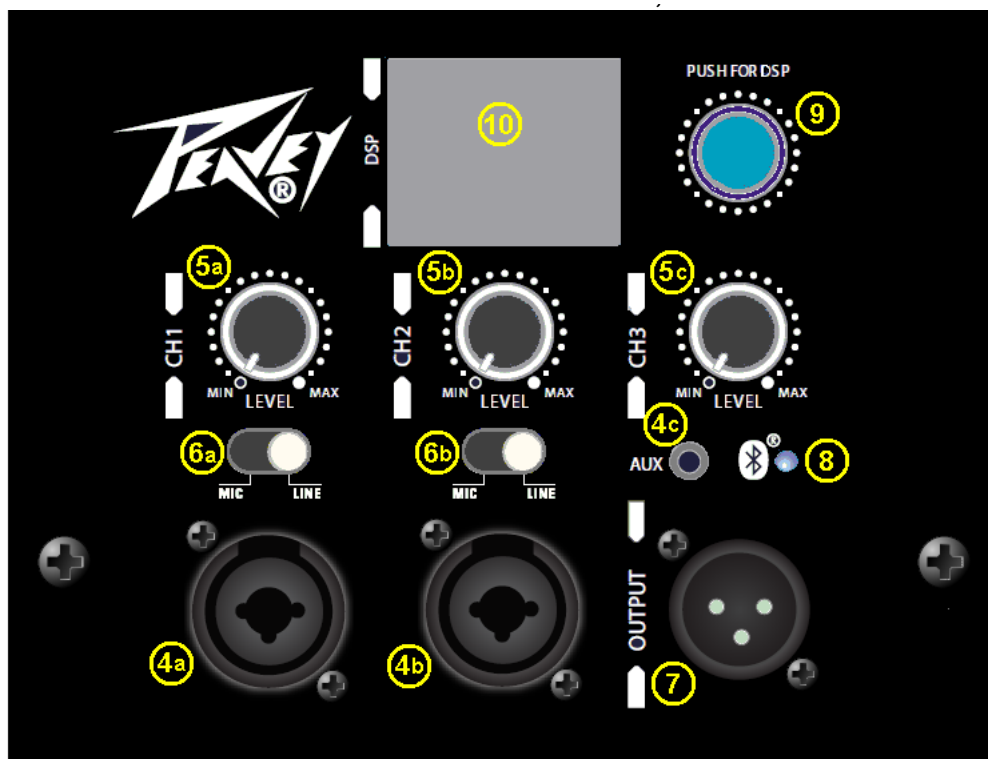

INPUTs (4)

The line-level inputs are of the medium impedance balanced type. For channels 1 and 2 (4a and 4b), the jack is a combo female XLR and 1/4" TRS connector. For channel 3 (4c), the optional AUX input jack is a 1/8" phone type. Otherwise, channel 3 is the Bluetooth input channel when the PVX™p 10 Bluetooth® is linked with a Bluetooth audio device. Sensitivity of the combo jacks is 0.50 volts for full output, and 0.18 volts for channel 3 (4c). See the Level Control Adjustment section below for more details on the input sensitivity with a range of DSP mixer gain settings.

Level (5)

Controls the gain or output level of the input signal. It is used to directly set the system output level for a given input channel input signal. All three channels can be mixed together, and made available at the Output jack (7)

MIC/LINE switch (6)

These control the gain of the Channel 1 (4a) and Channel 2 (4b) to switch from line level gain to mic gain levels. Gain is increased 40 dB when the switch is in the MIC position. DO NOT FEED A LINE LEVEL SIGNAL INTO THE INPUT WITH THE MIC/LINE SWITCH IN THE MIC POSITION! The analog input circuitry and the DSP system will overload and cause severe distortion that can not be removed by turning down the Level control !

OUTPUT jack (7)

This jack is intended for the use of linking multiple PVX™p 10's in a line or to provide a feed to a powered subwoofer, or other electronics that needs to receive a full range version of the input signal. The connector is a male XLR jack.

UPPER REAR PANEL

Bluetooth® LED (8)

Illuminates blue when the Bluetooth® channel has been activated. See the Bluetooth® section for more information.

Push for DSP (9)

This knob accesses the DSP system user control functions, which include a wide variety of trims and adjustments to the system, and to individual input channels, etc. See the DSP Menu section for more details.

LCD Screen for DSP Menu (10)

This screen displays the DSP menu options when the Push for DSP knob (9) is accessed and operated. See the DSP Menu section for more details.

Not shown in the above rear panel diagram is a front baffle LED which can be switched to OFF, ON (blue) when power is applied, and LIMIT to indicate when compression and limiting are occurring by flashing RED. This function is controlled by accessing the DSP system functions via the Push for DSP Knob (9).

CAUTIONS



The unit must be disconnected from the AC power source before any work is done on it. Refer all servicing to qualified service personnel.

The back plate can become hot to the touch. Do not block or cover the fan or the exhaust louvers from ventilation. There must be a minimum of 4" of space behind the fan. Do not allow the airflow to become blocked by objects such as curtains or drapes, thermal building insulation, etc. It is recommended that the rear of the PVX™p 10 Bluetooth® not be placed in a closed space or a space that has no fresh, cool airflow.

Be sure to keep the microphone away from the front of the speaker after connecting it to the input, and while setting the microphone level, or very loud feedback will occur! Damage to the system is likely if this occurs!



DO NOT connect the inputs of the PVX™p 10 Bluetooth® to the output of a power amplifier. The inputs are meant to be driven from a line-level strength signal.

DO NOT remove the protective metal grilles.

WARNING! The PVX™p 10 Bluetooth® is very efficient and powerful! This sound system can permanently damage hearing! Use extreme care setting the overall maximum loudness!

The apparent sound level of the PVX™p 10 Bluetooth® can be deceiving due to its clear, clean sound output. The lack of distortion or obvious distress can make the sound level seem much lower than it actually is. This system is capable of SPL in excess of 123 dB at 1 M from the speaker!

OPERATING INSTRUCTIONS

Flying the PVXp™10 Bluetooth®

IMPORTANT SAFETY INFORMATION FOR THE MOUNTING AND FLYING OF THE PEAVEY PVX™p 10 BLUETOOTH®



CAUTION: Before attempting to suspend this speaker, consult a certified structural engineer. Speaker can fall from improper suspension, resulting in serious injury and property damage. Other enclosures may NOT be suspended below one, nor should additional weight be suspended from one of these units. Use only the correct mating hardware. All associated rigging is the responsibility of others.

Maximum enclosure angle from vertical hang is 30 degrees.

Always use a suitable safety chain or wire rope, attached to an unused group of fly points or to the cabinet as directed by a certified structural engineer, and firmly attached to a suitable structural member as indicated by a certified structural engineer.

The recommended range of torque for the mounting bolts is 3.5 to 4.0 foot-lbs. (4.75 to 5.42 N-m). **DO NOT OVERTIGHTEN !** If an insert spins free, it has been damaged, and the cabinet can not be safely flown from that set of inserts!

Never transport the cabinet while mounted on an array bracket or other mounting bracket, this may unduly stress the mounting inserts.

The use of threadlocker (blue type/medium strength) on the mounting bolts is recommended, as are the appropriate lockwashers, to insure that the mounting hardware will not vibrate loose over time.

GROUPING OF INSERT SETS

Group A

A set of two widely spaced M8 inserts on the top, designed to hang the cabinet using the proper eyebolts.

Group B

A set of two widely spaced M8 inserts on the bottom, designed to hang the cabinet using the proper eyebolts.

Group C

A set of four M8 inserts on the top, designed to be used with the Peavey Versamount™ 70 mounting bracket.

Group D

A set of four M8 inserts on the bottom, designed to be used with the Peavey Versamount™ 70 mounting bracket.



For Group A and B, always use both inserts as a pair; NEVER use just one insert to fly a cabinet!

For Group C, and D, Always use all four inserts of a given group as a set; NEVER use just one insert to fly a cabinet! The four insert groupings are meant to have all four inserts used at once within a group.

Group D should only be used with the Versamount™ 70 oriented beneath the cabinet, and at an angle less than 30 degrees from vertical.

SPECIFICATIONS FOR INSERT MATING HARDWARE

Group A and Group B should use an M8 forged steel shoulder-type lifting eyebolt, which meets the requirements of DIN 580 or ASTM A489. They should only be used in pairs, and in conjunction with the rear most pair of M8 inserts on the same surface as a pull-back/aiming adjustment, using M8 eyebolts of a similar specification. The length of the threaded shank on the eyebolts should not exceed 0.709" (approx. 18 mm), so that it does not bottom out in the insert. Thread pitch: 1.25 mm per thread.

The length of the threaded shank into the cabinet on the rear M8 eyebolt should not exceed 0.709" (approx. 18 mm), so that it does not bottom out in the insert. Thread pitch: 1.25 mm per thread.

Group C should use an M8, grade 8.8 or better, 1.25 mm per thread, metric bolt, that does not penetrate the cabinet past the cabinet surface more than 0.709" (approx. 18 mm). When using a Peavey Versamount™ 70 mounting bracket and lock washer, the length of the bolt should not exceed 1.00" (approx. 25 mm).

Group D should use an M8, grade 8.8 or better, 1.25 mm per thread, metric bolt, that does not penetrate the cabinet past the cabinet surface more than 0.400" (10 mm). When using a Peavey Versamount™ 70 mounting bracket and lock washer, the length of the bolt should not exceed 3 / 4" (approx. 20 mm).



WARNING! (note to structural engineer)

The thread insertion depth past the surface of the cabinet of the end of the mounting bolt should not be more than 0.787" (20 mm) for insert groups A, B, and C, and not more than 0.400" (10 mm) for Group D.

If these thread insertion depths are exceeded, then the inserts may be damaged or unseated from the cabinet, severely compromising the mounting integrity of the cabinet!

For maximum mounting strength, safety and reliability, the bolt threads should engage at least 8 mm of depth for Group A, B, C, and D.

The PVX™p 10 Bluetooth® mounting insert groups C, and D are designed to be used with the Peavey® Versamount™ 70 mounting bracket (00454470 black, 00454460 white). It can also be used with the Peavey® Wall-Mount Speaker Stand (00922940 black, 00487390 white), which will fit into the built-in stand mount cup on the bottom of the cabinet.

Connecting AC Power To The PVX™p 10 Bluetooth®

The PVX™p 10 Bluetooth® comes with an 6-foot IEC connection AC power cord. If you are using an extension cord or power strip with this powered speaker, make sure it is of good quality and of a sufficient current capacity to maintain safety and maximize the power output capability of the PVX™p 10 Bluetooth®. For maximum undistorted output, do not connect any other device to the same extension cord that the PVX™p 10 Bluetooth® is connected to. Do not exceed the rated current capacity of the extension cord with the sum total of all units connected to it.

When first plugging in the AC cord, make sure the power switch is in the Off position, and then turn it On only once the power cord has been connected. Built-in muting will engage when the proper sequence of steps is taken.

Special Note for Permanent Installation

When installing the PVX™p 10 Bluetooth®, AC power runs will be used and a certified electrician should be consulted to be sure that all AC wiring complies with local codes and regulations. It is also advisable to use a cable clip properly

affixed to the cabinet to strain relief the IEC power cord connected to the amplifier module at (2) so the power cord cannot be pulled out or vibrate loose.

Use of the PVX™p 10 Bluetooth® with a Subwoofer Pole

The built-in stand mount cup allows use with the Peavey PVS™ series Subs and the threaded pole that comes with those models.

Always be sure to place the subwoofer used in this manner on a flat, level and stable surface.

Use of the PVX™p 10 Bluetooth® with a Speaker Stand

The PVX™p 10 Bluetooth® has a stand mount cup molded-in so that the system can be stand mounted on a standard 1 3/8" (36mm) diameter stand pole.

When using stands or poles, be sure to follow these precautions:

Check the stand or pole specs to make sure that it can support the weight of the PVX™p 10 Bluetooth® (28 lbs./12.7 kg), and observe all safety precautions stated by the stand manufacturer, including the maximum height the stand is rated for.

Always place the stand on a flat, level and stable surface, and be sure to fully extend the stand legs as per the stand manufacturer's instructions.

Try to make sure that the stand legs are oriented for the least danger of tripping to those in the vicinity of the stand. Never block a doorway or hallway with the legs of a stand.

Try to route cables so that people will not trip over them, or tip the speaker over. Use of duct tape, cable channels or guards, or other appropriate tie-down/cover-up devices should be carefully considered and implemented.

When installing or de-installing the speaker on the stand, it is a good practice to have a helper if possible, it can be hard to "thread the needle" and mate the stand cup to the stand pole while holding the PVX™p 10 Bluetooth® speaker system at arm's length. It is also helpful if someone holds the speaker stand and pole down while the PVX™p 10 Bluetooth® is removed from the stand pole, this prevents the PVX™p 10 Bluetooth® from pulling the pole up with it.

When using stands outdoors, never attach banners or flags to the stands or the PVX™p 10 Bluetooth® speaker system, strong winds may cause the speaker to blow over. If there is a possibility of windy conditions, then it may be prudent to consider weighting or locking down the stand legs to prevent the PVX™p 10 Bluetooth® speaker system from being blown over.

Connecting a Signal to the PVX™p 10 Bluetooth®

There are a variety of ways to input a signal to the PVX™p 10 Bluetooth®.

The inputs (4a and 4b) provides either a balanced mic- or line-level input, allowing the use of a 1/4" TRS (ring-tip-sleeve) type phone plug or a male XLR plug.

Do not connect cables to the jacks while the unit is ON and the Level knob is turned up! While a standard single-ended 1/4" phone plug-equipped shielded cable will work well, and the balanced input circuitry will provide some

interference rejection, a balanced cable using either the balanced TRS 1/4" phone plug or the XLR plug will provide superior interference rejection and performance.

Sometimes, with difficult interference problems, it will be helpful to lift the shield ground (Pin #1 of an XLR) of a balanced cable at the PVX™p 10 Bluetooth® end. Check any input changes carefully, always turning the Level control down before plugging and unplugging cables, or lifting the ground.

Use of high quality, premium cables is recommended for the PVX™p 10 Bluetooth®, as these usually have better shielding and materials and will provide greater long-term reliability. The best option is a shielded balanced cable no longer than necessary to reach the PVX™p 10 Bluetooth®. It is usually a good idea to leave some slack at the input to the PVX™p 10 Bluetooth® and also to tape the cables down or run them under a cable guard to avoid anyone tripping over them or pulling the PVX™p 10 Bluetooth® over when stand mounted.

Level Control Adjustment

The PVX™p 10 Bluetooth® is equipped with a Level controls (5a, b and c)) on the inputs to facilitate use in many different applications. With the Rear Panel Level control adjusted fully clockwise, and the DSP Master Gain at +10 dB, and the DSP Channel Gain at nominal (0 dB), the gain is such that the input sensitivity is 0.50 V RMS for full-rated output with the Combo jack. There is still 10 dB more gain available in the individual DSP Channel inputs, which makes the sensitivity with all DSP channel sliders full up, the DSP Master Gain full up, and the Level control full CW, approximately 0.16 V RMS.

If the PVX™p 10 Bluetooth® has been Factory Reset, or the App control turned OFF, then the default gain for the DSP Master Gain is set to 0 dB.

This results in a sensitivity of 1.58 V RMS with the Rear Panel Level control adjusted fully clockwise, and the DSP Channel Gain at default (0 dB).

We recommend the following gain structure for the PVX™p 10 Bluetooth® speaker system:

Rear Panel Level control starting out at straight up

DSP Master Gain at +10 dB

DSP Channel Gain at 0 dB

This results in a sensitivity of 0.50 V RMS for full power output.

When driving the PVX™p 10 Bluetooth® from a mixer, it may be advantageous to reduce the input sensitivity by turning the Level control to the halfway point. The PVX™p 10 Bluetooth® will now more closely match a typical power amp.

If the mixing board indicates clipping of its output signals, then all of the PVX™p 10 Bluetooth® power capability is not being utilized cleanly. Clipping the signal before it gets to the PVX™p 10 Bluetooth® is not optimal. Reduce the mixer output level and turn up the Level control on the PVX™p 10 Bluetooth®.

The amplifiers in the PVX™p 10 Bluetooth® are equipped with DSP controlled compression and limiting, and the LED indicator will show when PVX™p 10 Bluetooth® compression/limiting has engaged. If the sound seems heavily compressed, check this indicator; if it is blinking RED and is On more than it is Off, then the drive level from the mixer (or the Level control on the PVX™p 10) needs to be reduced.

When first turning on the sound system, switch on all upstream electronics first, then the PVX™p 10 Bluetooth® with its Level control fully counterclockwise (all the way down). Begin checking levels with the mixer output level controls all the way down, and bring them up slowly with the PVX™p 10 Bluetooth® Level control set to the desired setting (one-third way up recommended to start).

It is not good practice to turn the Rear Panel Channel Level controls on the PVX™p 10 Bluetooth® all the way up and then try to control level only from the mixer, this approach would tend to pick up excess noise. Best practice would be to run a "hot" signal from the mixer down the cable to the PVX™p 10 Bluetooth®, and then turn the PVX™p 10 Bluetooth® Level control up only as much as necessary to reach full desired output. With this approach, it is necessary to verify the mixer output is not clipping.

When using the system with Bluetooth® as a signal source, it is best to turn down the Bluetooth® channel (channel 3, 5c) until you are sure the signal level from your Bluetooth® source device is at a reasonable level, then adjust the relative gain between the PVX™p 10 Bluetooth® and the Bluetooth® source device.

Use of 1/8" AUX Jack Input (4c)

If using the 1/8" AUX input jack (4c), this channel has more gain than the XLR combo jacks, and how much depends on whether both of the "channels" on the 1/8" jack carry the same signal or not. The 1/8" input jack is a "stereo" jack, in that it has separate signal contacts for L and R on the tip and ring.

Since the PVX™p 10 Bluetooth® is a single speaker system, signals coming in on the 1/8" input jack with content on both channels are summed to mono, and then fed to the speaker system DSP preamp.

If there is a signal on only one channel, then the gain is 9 dB higher than the XLR combo jacks 4a and 4b. This creates a sensitivity of approximately 0.18 V RMS with the Rear Panel Level control adjusted fully clockwise, and the DSP Master Gain at +10 dB, and the DSP Channel Gain at nominal (0 dB).

With the Rear Panel Level control adjusted fully clockwise, and the DSP Master Gain at +10 dB, and the DSP Channel Gain full up (10 dB), this becomes 0.056 V RMS.

If the SAME signal is sent in on both channels of the 1/8" input jack, then the gain is increased by 6 dB, and the sensitivity voltages become 0.089 V RMS and 0.028 V RMS respectively.

It should be noted that this is a very high sensitivity with all the gain controls turned fully up, and when using the 1/8" input jack, it would be a good idea to

turn down both the Rear Panel Level control, and the DSP Master Gain, and the DSP Channel Gain to avoid a suddenly very loud signal presence.

A good starting point would be -10 dB on the DSP Master Gain, and also on the DSP Channel Gain, and start with the Rear Panel Level control down (CCW) all the way, and turn it up slowly with an active signal source feeding the 1/8" input jack.

It would be prudent to check your signal source default output setting (as in a Smart Phone feed), as it is not uncommon for this setting to be at a rather high level. If you are checking the gain with your device "turned down", and later, you go to hook it up again, in the meantime, it may have become reset to the default output level.

Level Indications on the LCD Display Screen (10)

The LCD screen for the DSP menu also displays a set of level indicator bars in each segment of the display, channels 1, 2, 3 and the Main (Master) segment. See Fig. A below, and compare to Fig. 1 a little bit further down.



Fig. A Level Indicator Bars

These indicator bars can be helpful in determining the relative level between channels, and to see the overall signal level structure. Note that they do not respond to quick, short transients, but are more of an averaging style of indication.

They will not be accurate to try and determine when the system has reached it's output limits, that would best be determined by turning the front baffle LED indicator to "Limit" mode, as outlined in the **Config** menu section below, see Figs 53, 54, and 55 and their associated explanations. Please note the information provided about when the LED indicator turns *RED* when the Limit indication function is selected.

Disconnecting AC Power to the PVX™p 10

We recommend that the Power switch (3) be used to turn the unit off first, and then the AC power cord can be removed, this minimizes stress to the power amplifiers and the transducers from turn-off transients. The power switch has an arc suppression capacitor to help during turn-off, and tends to make a clean disconnect from the AC power, while the power cord IEC connector can make intermittent contact before finally becoming fully disconnected, e.g., as when wiggling the cord.

DSP Menu

The DSP menu is accessed via the **Push for DSP** knob (9), and is displayed on the **LCD Screen for DSP Menu (10)**.

In this section, we will step through the DSP menu as it is displayed and as each layer is accessed.

When the unit is first turned on, it displays the Peavey® logo, and then a yellow bar across the bottom showing the progress of the loading into working memory of the DSP code, and the model is displayed above the progress bar until it is finished loading. Then you see the Main Start Screen.



Fig. 1 Main Start Screen

MAIN (MASTER) LEVEL ADJUST

If you turn the "Push for DSP" knob (9) CCW one notch, then the volume knob will become highlighted, if you push in the "Push for DSP" knob in, then the "dB" level indicator highlights, and turning the "Push for DSP" knob will change the Master Gain level, see figure below.



Fig. 2 Main (Master) Channel Gain (Default)

Here is an example of the gain being changed to +3 dB



Fig. 3 Main (Master) Channel Gain +3 dB

The Main (Master) Channel gain is variable from +10 dB to -80 dB.

CHANNELS 1 THRU 3 ADJUSTMENTS

If from the Main Start Screen of Fig. 1, you click the "Push for DSP" knob CCW 4 times, then you end up highlighting the CH1 segment, see below:

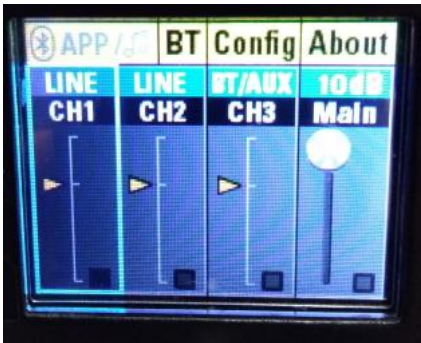

Fig. 4 Main Screen - CH1

Then if you push in the "Push for DSP" knob in, you will get the menu for Channel 1's controls. These consist of three bands of EQ, and an adjustable high pass filter. See Fig. 5 below:



Fig. 5 CH1 Selections

Turn the "Push for DSP" knob one click CW, and the High EQ band is selected. Push in the knob to activate the EQ slider. Now turning the knob CW increases the HF boost above 8 kHz up to 6 dB, then turning it all the way CCW the high frequencies are cut by 6 dB, in 1 dB increments.

See Fig. 6 and Fig. 7



Fig. 6 CH1 High band EQ, +5 dB



Fig. 7 CH1 High band EQ, -3 dB

From Fig. 5, turn the "Push for DSP" knob two clicks CW, and the Mid EQ band is selected.



Fig. 8 CH1 Mid band EQ

Push in the knob to activate the EQ slider. Now turning the knob CW increases the Mid boost at 600 Hz by up to 6 dB, turning it all the way CCW cuts the Mid frequencies by up to 6 dB, in 1 dB increments. See Fig. 9 and Fig. 10



Fig. 9 CH1 Mid band EQ, +3 dB



Fig. 10 CH1 Mid band EQ, -3 dB

From Fig. 5, turn the "Push for DSP" knob three clicks CW, and the Low EQ band is selected.



Fig. 11 CH1 Low band EQ

Push in the knob to activate the EQ slider. Now turning the knob CW increases the Low boost at 100 Hz by up to 6 dB, turning it all the way CCW cuts the Low frequencies by up to 6 dB, in 1 dB increments. See Fig. 12 and Fig. 13



Fig. 12 CH1 Low band EQ, +3 dB



Fig. 13 CH1 Low band EQ, -2 dB

From Fig. 5, turn the "Push for DSP" knob four clicks CW, and the HPF Filter band is selected. HPF stands for **H**igh **P**ass **F**ilter, which rolls off low frequencies. See Fig. 14.



Fig. 14 HPF Filter Band

The default filter frequency is 20 Hz, and the filter type is a 2nd order Bessel. Normally, there is no need to change this setting, but if the speaker will be used for speech only, or other limited bandwidth signal sources, or with a microphone exposed to the wind, or excessively plosive talkers, etc. then raising the frequency of this filter may be helpful in taming these undesired sounds. Note that raising the frequency to a value above 20 Hz *WILL* start to roll-off the lower frequencies, and limit how low a frequency the speaker system can reproduce. Setting the filter very much higher than 140 Hz should not be necessary except in extreme and unusual circumstances. The range of frequencies it can be set to are from 20 Hz to 400 Hz. Also note that the entire speaker system is protected by a 36 dB/oct. infra-sonic filter, and this HPF Channel filter is added on top of that existing filtering.

An example of the HPF set to 50 Hz is shown below in Fig. 15



Fig. 15 HPF set to 50 Hz

Note that CH3, the set of Gain and EQ controls for the Bluetooth® signal source, does not have this filter available, as most pre-recorded music or sources do not have very much extreme low-frequency content or opportunity to generate excessive plosives or mic noises, etc.

To exit the CH1 EQ and Filter settings, after making any changes to the EQ or Filter, turn the "Push for DSP" knob until the arrow pointing to the left in the upper right hand corner of the screen turns from black to light blue. See Fig. 16, where the blue arrow is circled in red.



Fig. 16 Exit CH menu

Pushing in the "Push for DSP" knob will return you to the Main Screen - CH1, Fig. 4

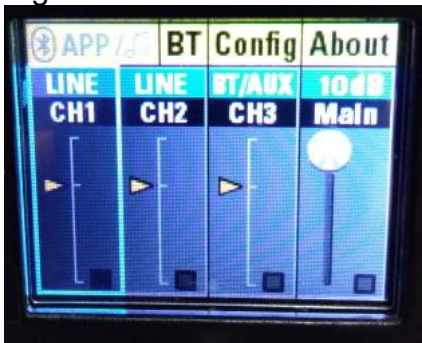

Fig. 4 Main Screen - CH1

From here, you can use the "Push for DSP" knob and rotate it to arrive at any of the channels desired, such as CH2, and active it's EQ and Filter menu as outlined above for CH1. See Fig. 17.



Fig. 17 CH2 Selections

Similarly, you can reach CH3, the adjustments for the Gain and EQ controls for the Bluetooth® signal source, and push in the "Push for DSP" knob to access these channel settings. As noted above, this channel does not have any HPF or adjustments for same.

PARAMETERS MENU

From the Main Start Screen, Fig. 1, if you push in the "Push for DSP" knob instead of rotating it, a menu screen comes up that allows for adjustment of the following speaker system parameters:

- MODE
- LOCATION
- DELAY
- OUTPUT

See Fig. 18



Fig. 18 Parameters Menu

Mode selects the speaker system EQ Preset.

Location selects the physical location of the speaker with respect to physical boundaries.

Delay selects how long the input signal is delayed before it is output as sound.

Output selects the mode of the Output jack, *Mix* or *Thru*

Turning the "Push for DSP" knob one click CW highlights the Mode parameter, push in the "Push for DSP" knob, and the parameter is selected.

See Fig. 19



Fig. 19 Mode Parameter Selected

Turning the "Push for DSP" knob brings up the other Mode selections:

Live



Fig. 20 Live Mode Highlighted

Club



Fig. 21 Club Mode Highlighted

and

Speech



Fig. 22 Speech Mode Highlighted

Once a given Mode has been highlighted, pressing the "Push for DSP" knob will select that Mode, and the highlight will end.

The "Push for DSP" knob can now be rotated to the next parameter or to Exit.

To Exit, turn the "Push for DSP" knob until the arrow pointing to the left in the upper right hand corner of the screen turns from black to light blue.

See Fig. 16, where the blue arrow is circled in red. Then push in the "Push for DSP" knob once the Exit arrow has turned blue.

Normal Mode provides the flattest frequency response.

Live Mode provides a slight boost at the frequency extremes and some midband EQ.

Club Mode provides more boosts at the frequency extremes, with the emphasis on some extra bass, and with some upper midrange EQ.

Speech Mode rolls off the frequency extremes, and provides a boost in the presence range for improved vocal intelligibility.

Location Parameter

The Location parameter can be accessed from the Parameter menu (Fig. 18) by rotating the "Push for DSP" knob, and selecting the Location parameter, see Fig. 23



Fig. 23 Location Parameter Selection

Pushing in the "Push for DSP" knob when it is on this parameter will highlight that parameter, see Fig. 24



Fig. 24 Bracket Location Selected



Fig. 25 Pole Location Selected



Fig. 26 Monitor Location Selected

The **Pole** location provides slight bass boost to compensate for the speaker system being away from any boundaries such as a wall or corner. It assumes that the speaker system is at least 6 feet or more off the ground on a pole or stand.

The **Bracket** location is for nominal wall placement of the speaker system. This location setting provides a nominally flat response in the bass under anechoic conditions. This combined with the **Normal** mode Preset provides the very flattest response the speaker is capable of.

The **Monitor** location setting corrects for the bass boost that floor placement provides, by slightly reducing the overall bass level to compensate.

These three location settings along with the four Presets provide for 12 different EQ profiles that are repeatable and precise. These coupled with the Channel EQ (Low Mid and High band EQ) provide for literally thousands of repeatable and precise EQ settings available to the end user.

CAUTION!

This speaker system has built-in EQ and frequency shaping to achieve a basically flat frequency response, as well as Presets and EQ settings available that can have significant amounts of bass boost beyond a nominally flat response. It is strongly recommended that you not ADD additional bass boost EQ external to the speaker system, as this will pose a very real probability of creating an overload situation, where the vocals or high frequencies are left weak and muddled, and the apparent loudness of the speaker system will be

curtailed due to this imbalance in bass EQ. Let the speaker system's built-in EQ work FOR YOU, and do not attempt to try and make it behave as if it were a Subwoofer equipped cabinet.

Delay Parameter

The Delay parameter can be accessed from the Parameter menu (Fig. 18) by rotating the "Push for DSP" knob, and selecting the Delay parameter, see Fig. 27



Fig. 27 Delay Parameter

Note that these are NOT mis-spelled ON and OFF selections, they are zero meters and zero feet.

Push in the "Push for DSP" knob to highlight this parameter, see Fig. 28



Fig. 28 Delay Parameter Selected

This can adjust the entire speaker systems signal delay to 33 feet or 10 meters, in one meter increments. 10 meters/33 feet is approximately 29 ms, and 1 meter/3.28 feet is approximately 2.91 ms. See Fig 29



Fig. 29 Delay Parameter at Maximum

This parameter would normally not be used for live sound on stage situations, but rather, for when the speaker system is used as a side fill or for delay towers. Should be set to 0 delay for almost all live sound situations.

Output Parameter

The Output parameter selects either Mix Out or Link Out, see Fig. 30



Fig. 30 Output Parameter, Mix Out Selected

Mix Out is the combined post fader/EQ signal of Ch1, Ch2 and Bluetooth channels mixed together. In this mode, the channel EQ/faders will affect the signal level at the output jack.

Link Out is the combined pre fader/EQ signal of Ch1, Ch2 and Bluetooth channels mixed together.

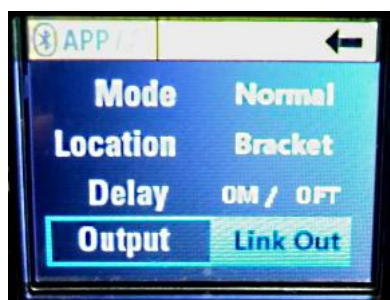

Fig. 31 Output Parameter, Link Out Selected

BLUETOOTH® OPERATION

Bluetooth® Controls

How to Turn OFF the blinking Bluetooth® LED (8) if you are not going to be using Bluetooth®

From Fig. 1 the Main Start Screen, if you turn the "Push for DSP" knob (9) CW one notch, then the BT menu header will become highlighted, see Fig. 32 below. Pushing in the "Push for DSP" knob in selects the BT menu, see Fig 33 below. Turning the "Push for DSP" knob CW two notches selects the Streaming parameter, see Fig. 38 below.

Push in the "Push for DSP" knob to enter the Streaming menu, and turn the "Push for DSP" knob one notch CW to select OFF, see Fig. 39 below.

Push in the "Push for DSP" knob to turn the Streaming OFF, and the Bluetooth® LED (8) will turn OFF.

Then, turn the "Push for DSP" knob two notches CCW to reach the blue Exit arrow (See Fig. 16 for the Exit arrow circled in Red) and press the "Push for DSP" knob in to return to the menu screen with the Bluetooth® menu highlighted (Fig. 32), then rotate the "Push for DSP" knob CCW one notch to return to the Main menu screen of Fig. 1

Bluetooth® Functions

From Fig. 1 the Main Start Screen, if you turn the "Push for DSP" knob (9) CW one notch, then the BT menu header will become highlighted, see Fig. 32



Fig. 32 Bluetooth® Menu header Highlighted

Pushing in the "Push for DSP" knob in selects the BT menu, see Fig 33.



Fig. 33 Bluetooth® Menu

Turning the "Push for DSP" knob CW one notch selects the App Control parameter, see Fig. 34.



Fig. 34 App Control selected

App control

There are three available settings; On, Off and Secondary.

- "On" allows the speaker to be controlled with the PVX™p App (available for the iPhone® only). See "Bluetooth® Connection Instructions" for how to connect the speaker to a Bluetooth® device. It should also be set to "On" when this is the primary speaker in the linked configuration, and app control of the linked speakers is desired. Push in the "Push for DSP" knob to select the App Control parameter. See Fig. 35

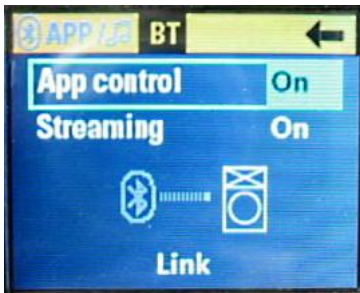

Fig. 35 App Control On highlighted

- "Off" disconnects the speaker from App control and resets the internal DSP gains to 0 dB on the Gain slider. Rotate the "Push for DSP" knob CW to select the Off parameter, and then push it in. See Fig. 36

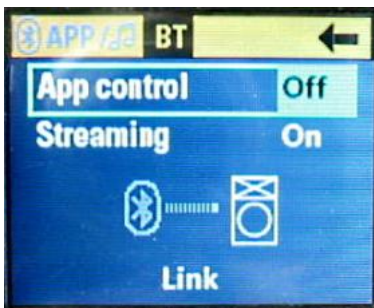

Fig. 36 App Control Off highlighted

The App Control is now Off, and the PVX™p speaker system is operating without any outside control by a Bluetooth® device. Certain Bluetooth® operations can still be performed using the PVX™p speaker system's controls.

- "Secondary" allows the speaker to be controlled by the app when two speakers are linked. The secondary speaker will be the Right speaker in this setup. See complete instructions in the "Linking Speakers" section. Rotate the "Push for DSP" knob CW to select the Secondary parameter, and then push it in. See Fig. 37

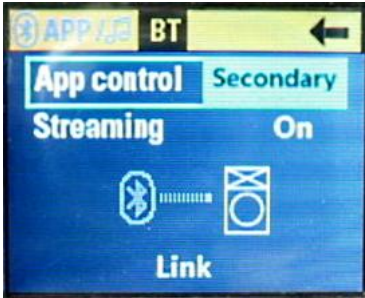

Fig. 37 App Control Secondary parameter highlighted

Streaming

There are two available settings, "On" or "Off". It should be set to "On" to enable the speaker to receive audio from a handheld Bluetooth® device.



Fig. 38 Streaming parameter On

It can be turned off to prevent the speaker from receiving audio from an unwanted source. See Fig. 39



Fig. 39 Streaming parameter Off

Link Speakers

The PVX™p speakers can be linked together to create a stereo system or a mono system with two speakers. Additionally, it can be controlled with the App.

To setup a simple stereo system, no Bluetooth® streaming.

- On the primary PVX™p speaker, App Control and Streaming should both be turned off.
- On the secondary PVX™p speaker, App Control should be set to Secondary and Streaming should be off.

- On the primary speaker, use the "push for DSP" knob to navigate to the "LINK", push in the knob to activate the linking action. See Fig. 40.



Fig. 40 Link parameter selected

- Once they connect, the primary speaker will be the Left channel and the secondary speaker will be the Right channel. The Left/Right signals can be swapped within the app.

•

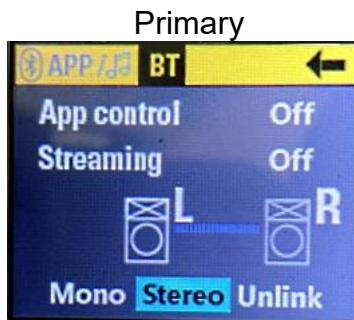

Fig. 41

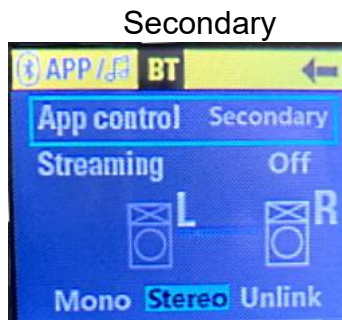

Fig. 42

In order for this to work well, the Secondary speaker must be in Bluetooth® range of the Primary speaker, and in order to have a good clean connection, it would be wise to make sure that the Secondary speaker is well within the range of the Primary, and that there are no metal walls, or other RF shielding structures between the two speakers.

To add Bluetooth® streaming:

- On the primary (Left) PVX™p speaker, turn Streaming from "Off" to "On".
- On your device, make a Bluetooth® connection to the PVX™p speaker.
- The volume of the Bluetooth® signal will be controlled by the CH3 Level controls on each PVX™p speaker (independently).

To add App control:

- On the primary PVX™p speaker, turn App control from "Off" to "On".
- The App should connect to and control both linked PVX™p speakers.

Auto Link

If it is desired that the PVX™p speakers link all of the time as part of a permanent setup, the two speakers can be set to automatically link every time they are turned on.

- On each PVX™p speaker (Primary and Secondary), navigate to the "Config" screen. See the Config Menu section below this section.
- Change the "Auto Link" setting from "Off" to "On".

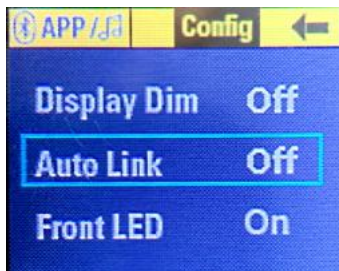

Fig. 43

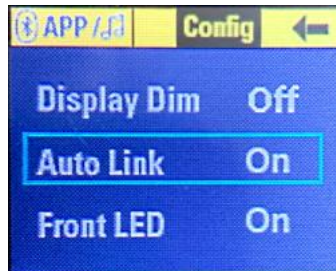

Fig. 44

To stop the Auto Link feature, simply turn it back to "Off" on each speaker.

Bluetooth Connection Instructions:

Streaming Audio

- On the PVX™p speaker, navigate to the Bluetooth® screen (BT header and subsequent menu, Fig. 33, 34)
- Set Streaming to "On"
- The PVX™p speaker's Bluetooth® LED (8) will start blinking
- On your Bluetooth® device, navigate to Bluetooth® settings
- Select PVXp speaker
- The Bluetooth® device should change from "Not Connected" to "Connected"
- Once connected, the PVX™p speaker Bluetooth LED (8) will light solid.

App Control

- In the Bluetooth® App Control menu, change the PVX™p speaker's "App Control" from "Off" to "On".
- Open the App on your Bluetooth® device. The speaker should connect automatically.
- The PVX™p speaker Bluetooth® LED (8) will light solid.
- The connected speaker will be listed at the top of the App in the Device list.

Bluetooth® Range Information

This is a Class 2 Bluetooth® device, and as such is designed to have a typical maximum range of approximately **10m**. However, any intervening materials, such as walls, shelves, screens, people, or most anything made of a substantial amount of metal, can reduce and affect that range.

CONFIG MENU

From Fig. 1 the Main Start Screen, if you turn the "Push for DSP" knob (9) CW two notches, then the Config menu header will become highlighted, see Fig. 45



Fig. 45 Config Menu Header

Pushing in the "Push for DSP" knob in will then bring up the Config menus, see Fig. 46

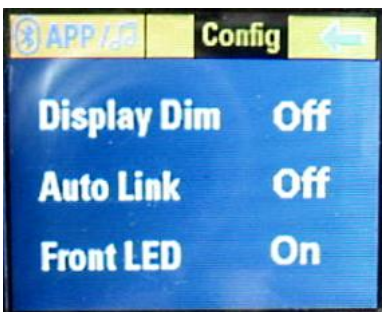

Fig. 46 Config Menu Selections

The selection choices are:

Display Dim

Auto Link

Front LED

If you turn the "Push for DSP" knob (9) CW one notch, the Display Dim choice will be highlighted, see Fig. 47.



Fig. 47 Display Dim highlighted



Fig. 47A Display Dim Selected

Push in the "Push for DSP" knob in to select the Display Dim choice. You can now change the Display to Dim, and the selection will show that the function is "On", see Fig. 48.



Fig. 48 Display Dim turned On

This will reduce the brightness of the display, so that when the speaker system is used as a floor monitor, the LCD screen is not so bright towards the audience, or if it needs to be dimmed for on stage use. The screen will dim once the navigation knob is not moved for 10 seconds.

AutoLink

Auto Link allows two speakers in range of each other to automatically link to form a stereo or dual mono system.

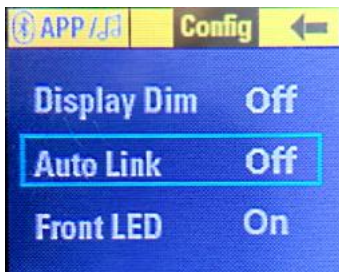

Fig. 49



Fig. 50



Fig. 51

See **Bluetooth® Controls** and the **Auto Link** section for more details.

Front LED

From the **Config** Menu Selection screen (Fig. 46), if you turn the "Push for DSP" knob (9) CW three notches, the Front LED choice will be highlighted, see Fig. 52.



Fig. 52 Front LED Selection Highlighted

Pushing in the "Push for DSP" knob will select the Front LED parameter, see Fig. 53



Fig. 53 Front LED Selected

The Front LED is mounted on the front baffle behind the grille, and the LED lights up Blue to show power has been supplied to the speaker system.

Rotating the "Push for DSP" knob will then change that parameter from On to Off, see Fig. 54



Fig. 54 Front LED turned Off

Turning the "Push for DSP" knob one more notch will chose the Limit function of the Front LED. See Fig. 55



Fig. 55 Front LED parameter set to Limit

Push in the "Push for DSP" knob to select the Limit parameter for the Front LED, and to exit the Config Menu Selection screen, rotate the "Push for DSP" knob till the arrow in the upper right hand corner turns blue, then press the "Push for DSP" knob again to return to the Main Menu screen.

About the Limit Function of the PVX™ p 10 Bluetooth® Speaker System

Choosing the Limit parameter allows the Front LED mounted on the baffle behind the grille to flash RED when the sophisticated DSP based compression and limiting system engages.

Note that this LED indication when the Limit parameter is selected does NOT indicate amplifier clipping or system distress, it is OK for it to turn RED on a regular but intermittent basis, as it just confirms that the compression and limiting system is doing it's job providing as much clean and unclipped output as possible. However, in the event that the LED is lighting up RED more often than not, it would be wise to turn down the drive level, so that excess compression does not occur to the sound.

ABOUT Header

From the Main Start Screen (Fig. 1), you turn the "Push for DSP" knob three notch's CW, and the About header will be highlighted. See Fig. 56



Fig. 56 About header highlighted

Press in the "Push for DSP" knob, and the About menu will be selected, see Fig. 57

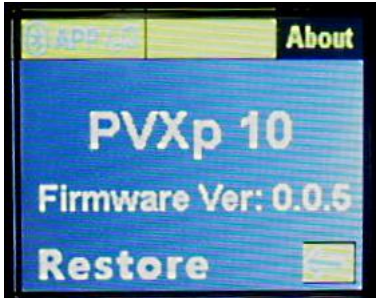

Fig. 57 About Menu

This displays the Model number of the PVXp, the firmware version, and the Restore function. Turn the "Push for DSP" knob, and the Restore function will be highlighted, see Fig. 58

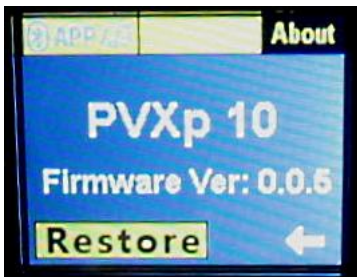

Fig. 58 Restore Function Selected

Pressing in the "Push for DSP" knob will bring up the menu choice for the Restore function, see Fig. 59.

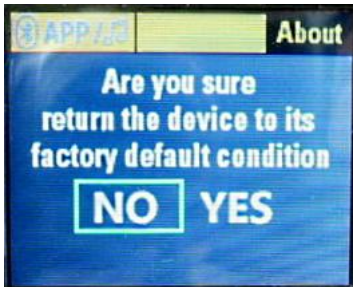

Fig. 59 Restore Function Menu

Turn the "Push for DSP" knob, and it will change the menu selection from NO to YES. See Fig. 60.

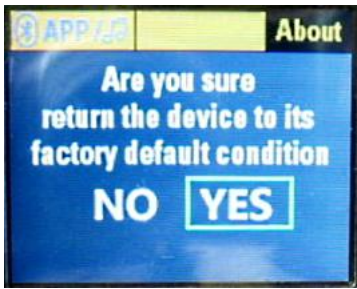

Fig. 60

If you push in the "Push for DSP" knob now, the unit will restore to Factory Defaults, and any custom set-up will be lost and have to be re-entered.

In order to assure proper operation, we recommend that the speaker system be turned OFF, and turned back on again before using it or re-loading any previously desired settings.

All previously loaded gain settings, Presets, Channel EQ choices, filter settings, etc., will need to be re-loaded into the speaker system after a Factory Reset event.

Normally, each time a change is made to the speaker system, whether it is the Preset used, or the Location, or the Bluetooth® system, it will be saved, and on powering the speaker system back ON, those settings will automatically come back up. Using the Restore function can be helpful if someone has altered the settings such that the speaker system will not function normally, or the files have become corrupted due to a power spike, a brown-out, etc.

IOS APP FEATURES

The PVXp Bluetooth speakers can be controlled remotely via the PVXp Application on any iOS device. Application is available for download on the Apple App Store.

The app controls are listed below. See also page 27 and page 32 of this manual.



Upon opening the application, the above screen will be displayed, prompting connection to the PVXp system.



*Note- Red arrows indicate the location of the physical gain knobs on the back of the speaker.

The home screen display contains a level control for all three channels and a blue edit button above each channel for access to EQ adjustments at the channel level, as well as individual channel mutes. The Master level will always be displayed on the right side for easy access.



Pressing the blue Edit button will allow access to the Channel-level EQ controls. See also pg 21



The blue "SETUP" button allows access to the following functions: Mode, Location, Delay, and Output Mode.



The blue "Scenes" button will allow user easy access to save and load settings for specific applications.

Additional features of the app are shown in following screens.



Connect and disconnect speaker via Bluetooth.



Control Display, Allow Auto Linking, and Allow LED display to signal Bluetooth connection.



Software information

No Output at All

First, make sure the unit has AC power and is turned ON. Make sure the LED on the power amp module is illuminated.

If not, make certain the ON/OFF switch (3) is in the ON position and check the IEC power cord connection (2) by ensuring it is fully engaged and seated. Make certain the AC line cord is plugged into a working AC outlet. Finally, check the fuse (1). (See the Rear Panel: Fuse section, for safety instructions.)

Once assured your unit is getting AC power, check that the PVX™p 10 Bluetooth® is getting a signal. Temporarily disconnect the cable running to its inputs and connect it to some other device capable of reproducing the signal (i.e., a power amp and speaker). If this produces a signal, make sure that all Level controls being used have been turned up to a satisfactory level (one-third to halfway).

If the PVX™p 10 Bluetooth® has been subjected to direct sunlight or excessive heat, the built-in thermal protection may have been triggered. If so, turn off the PVX™p 10 Bluetooth® and let it cool for a sufficient amount of time.

Try doing a system Restore, as described above in the DSP operating section, this will return the unit to its Factory Defaults, and reset all the controls to a nominal setting, allowing the gain and frequency response to return to "normal".

If there is still no output, contact your authorized Peavey dealer or the Peavey International Service Center.

Hum or Buzz

If the PVX™p 10 Bluetooth® is producing a hum or buzz, this can be AC outlet related. Try plugging the PVX™p 10 Bluetooth® into a different AC outlet. Sometimes, if a different circuit (breaker) is used for the mixer and for the PVX™p 10 Bluetooth®, it can cause hum problems. Unless it is not practical, it is best to use the same wall outlet (breaker) to supply power to both the mixer and the powered speaker.

Ensure that shielded cables have been used to route the signal to the PVX™p 10's input. If speaker cables with 1/4" plugs are used as input cables instead of shielded cables, they will be prone to hum or buzz.

Hum may be ground loop related. It may be helpful to lift the shield ground (Pin #1) on a balanced cable at the PVX™p 10 Bluetooth® end. Check any input changes carefully by first turning down the Level control, before plugging and unplugging cables, or lifting the shield ground at the speaker end.

Check to make sure light dimmers are not on the same circuit as the PVX™p 10 Bluetooth®, the mixer or any source devices. If light dimmers are used, then it may be necessary to turn them full ON or full OFF to eliminate or reduce hum. This is a typical AC wiring/light dimmer interference problem, not a design flaw of

the PVX™p 10 Bluetooth®.

The third wire (ground plug) on the AC plug should NEVER be removed or broken off, as this is a potential safety hazard.

Check that the input plug is fully seated in the input jack on the rear panel of the PVX™p 10 Bluetooth®.

Ensure that a power amp has not been plugged into the input jack of the PVX™p 10 Bluetooth®.

If an extension cord is being used to provide the AC power to the unit, insure that it is of sufficient current capacity and that it is not also being used to supply power to any other device.

The PVX™p 10 Bluetooth® has built-in EQ to extend and smooth the natural response of the speakers in the system. If excessive additional bass boost or HF boost have been added externally to the PVX™p 10 Bluetooth®, it could cause premature overload at high SPL. Reduce the amount of any external (mixer, rack) EQ and see if that clears up the distortion.

Finally, realize that even though the PVX™p 10 Bluetooth® is a powerful and high output unit, it does ultimately have limits, and it may need additional powered units (or a subwoofer) to provide enough sound output or coverage. In this case, try turning the mixer levels down a little to see if that clears things up. If, after checking all the things listed to check and anything else you can think of to check safely, and the system still exhibits problems, carefully note all conditions and check with your Peavey dealer for advice.

Care and Maintenance

Your PVX™p 10 Bluetooth® is a sturdy and durable product and will provide years of reliable use if properly cared for. Use common sense and read the safety warnings to avoid hazardous operating conditions.

The unit must be disconnected from the AC power source before any work is done on it. Refer all servicing to qualified service personnel.

Sunlight/Heat

Avoid prolonged exposure to direct sunlight, as this may cause the unit to overheat and thermally shut off.

Excessively hot operating conditions can also cause a thermal shutdown.

Do not store in extremely hot or cold conditions or extremely high humidity.

Always allow unit to come to room temperature before use.

Cleaning

Never clean the PVX™p 10 Bluetooth® while plugged in or turned ON! When the unit has been fully disconnected from AC power sources, use a dry cloth to remove soil or other dirt. Never use strong solvents on the PVX™p 10 Bluetooth®, as they could damage the cabinet. Do not allow ANY fluids to drip inside the PVX™p 10 Bluetooth®.

Touchup

For an overall finish enhancement and protective coating, use gloves to apply a plastic finish protector, such as Armor-All® protectant or a similar product, to the surface of the plastic cabinet only. Note that the cabinet will be slippery after these treatments; rub them down firmly with a dry, lint-free cloth to minimize this.

Check for Secure Hardware

After the first few months of use and periodically thereafter, check the hardware of the PVX™p 10 Bluetooth® for tightness, including the rear panel screws and the screws that hold the baffle and rear cabinet together.

The unit is subject to a great deal of vibration, and this could cause them to loosen with use.

Architectural and Engineering Specifications

The powered loudspeaker system shall have a frequency response from 65 Hz to 20 kHz. The peak SPL with inaudible distortion shall reach 123 dB with music as a source, when measured at a distance of 1M and driven to full output capacity. The system shall utilize a Peavey® Pro™ 10 10" heavy-duty woofer and a Peavey® RX™ 10 1.0" titanium diaphragm dynamic compression driver. The nominal radiation pattern shall be 100° in the horizontal plane, and 60° in the vertical plane. Axis of the vertical main polar lobe is angled down 10 degrees, resulting in the angular pattern with respect to straight ahead being +20, -40 degrees

The powered, bi-amplified loudspeaker system shall have three input channels consisting of a medium impedance input connector consisting of one combo female XLR and 1/4" TRS phone jack for channel 1 and channel 2 on the rear panel. Channel three shall provide Bluetooth® signal source input control, as well as doubling as an AUX in for a 1/8" phone jack.

There shall be a output connector consisting of a male XLR jack.

The system power amplifiers shall have an unfiltered frequency response of 20 Hz to 20 kHz which deviates no more than +0, -3 dB up to rated power, hum and noise better than 90 dB below rated power, and THD and IMD of less than 0.5%. The woofer amplifier shall be capable of 160W sine wave power output into a 4 ohm nominal load, and the tweeter amplifier shall be capable of 45W sine wave power output into a nominal 8 ohm load (with compression and limiting bypassed), and both shall incorporate independent DSP controlled signal compression.

The input signal shall be electronically divided into high frequencies and low frequencies by a fourth order slope line-level crossover at 1.8 kHz. The low frequencies shall be processed to provide bass boost, subsonic filtering and overall response shaping, and the high frequencies shall be equalized for response-shaping.

The enclosure shall be constructed of injection-molded plastic with a UL flame rating, and reinforcing ribs internally. A handgrip shall be incorporated on the right side near the woofer and towards the front of the cabinet.

A separate powder-coated metal grille shall be provided for horn and woofer protection. The cabinet shall incorporate a pole mount for speaker stand use, four tall sturdy rubber feet for floor standing use, and two sets of mounting point inserts on the top and bottom each, for flying use.

The outside dimensions shall be: 20.0" (50.8 cm) tall x 12.69" (32.2 cm) wide x 11.06" (28.1 cm) deep, and the weight shall be 27 lbs. (12.4 kg). Power requirements shall be: 100 Watts nominal, 100-120 VAC, 50/60 Hz Domestic and 220-240 VAC, 50/60 Hz (Export). The loudspeaker system shall be called a Peavey PVX™p 10 Bluetooth®.

SPECIFICATIONS

Frequency Range, 1 meter on-axis, swept-sine in ½ Space environment:
52 Hz to 20 kHz

Frequency Response, 1 meter on-axis, swept-sine in anechoic environment:
65 Hz to 20 kHz (±3 dB)

Usable Low Frequency limit (-10 dB point anechoic):
54 Hz

Nominal sensitivity (1W @1M, swept sine input in anechoic environment):
96 dB (average)

Maximum Sound Pressure Level (1 meter):
123 dB SPL peak with music

Radiation Angle measured at -6 dB point of polar response:
Nominal: 100 degrees horizontal X 60 degrees vertical
(Axis of the vertical main polar lobe is angled down 10 degrees, resulting in the angular pattern with respect to straight ahead being +20, -40 degrees)

Transducer Complement:
Heavy-duty 10" woofer with 2 3/8" voice coil & 50 oz. magnet
RX™10 1.0" titanium diaphragm dynamic compression driver

Box Tuning Frequency:
75 Hz

Electroacoustic crossover frequency: 2,000 Hz

Crossover type:
Advanced DSP based filter also providing driver EQ, level matching, bass boost, limiting, compression and subsonic filtering.

Crossover Slopes:

Nominally 24 dB/octave (4th order) low pass, 24dB/octave (fourth order) high pass, both with driver EQ incorporated.

Input Connections (Each, Channels 1 and 2):

One combo female XLR and 1/4" phone jack providing balanced line-level operation. Mic/Line switch provides extra gain for microphone use.

Input Connections (Channel 3):

AUX is a 1/8" phone type jack. Channel 3 is nominally the Bluetooth® signal source channel.

Output Connection:

One male XLR jack. This jack is intended for the use of linking multiple PVX™p 10's in a line or to provide a feed to a powered subwoofer, or other electronics that needs to receive a full range version of the input signal.

Enclosure Materials & Finish:

Black injection-molded plastic with textured surface, black powder-coated perforated grilles.

Mounting provisions:

Unit has two sets of two M8 inserts, one pair on the top, and one pair on the bottom.

Additional mounting points are a set of four M8 inserts on the top, and a set of four on the bottom, which use the Peavey VersaMount™ 70 mounting bracket. Four rubber feet provide vibration free floor or stage use, and a molded-in stand mounting cup is on the bottom.

Dimensions (H x W x D):

Rear:

19.62 in. x 7.19 in. x 11.06 in.

508 mm x 322 mm x 281 mm

Front:

20.00 in. x 12.69 in. x 11.06 in.

498 mm x 183 mm x 281 mm

Net Weight:

27 lbs. (12.4 kg)

ELECTRONICS AND AMPLIFIER SPECIFICATIONS**Internal power amplifiers Power Ratings (@120 VAC line):**

Total of 520 watts peak dynamic power

Woofer - 400 watts peak dynamic power

Sine wave Power*: 160 watts @ less than 1% distortion
Tweeter - 120 watts peak dynamic power
Sine wave Power*: 45 watts @ less than 1% distortion.

* Before DSP compression and limiting engages.

Electronic Input Impedance (Nominal):

Line: 20 k ohms balanced (1/4" and XLR), 15 k ohms unbalanced 1/4",
6.4 k ohms 1/8" jack
Mic: 2.7 k ohms balanced (XLR) No phantom power available.

Input Sensitivity for Full Output (Channel Input Level knob full CW, Master DSP gain full-up, DSP CH1 or CH2 at 0 dB):

1 / 4" TRS /XLR combo jack: 0.50 V RMS

See **Level Control Adjustment** section for more details under different channel and Main Gain settings.

DSP Specifications: DSP Input and Output is at 48 kHz and 24 bits, internal processing is 56 bit double-precision. Latency: 1.2 ms

Infrasonic filter protection: Minimum 36 dB/octave roll-off, 48 dB/octave roll-off with adjustable input filters engaged.

Nominal Amplifier Frequency Response: +0, -3 dB from 20 Hz to 20 kHz

Hum and Noise: Greater than 90 dB below rated power

Overdrive Dynamic Range: Greater than 15 dB

THD and IM: Typically less than 0.5 %

Power requirements of Peavey PVX™ p 10 Bluetooth® System:

Nominal 100 Watts, 100-120 VAC 50-60 Hz

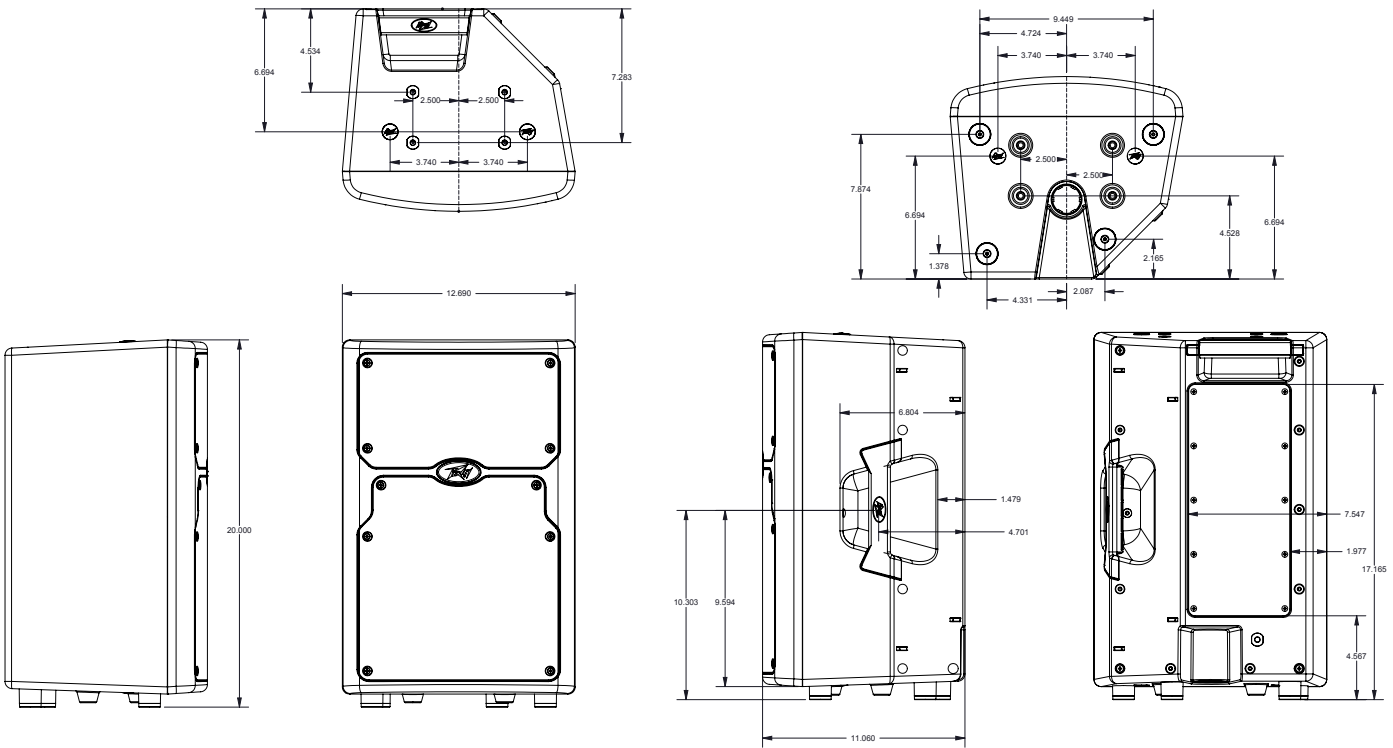

www.peavey.com

Warranty registration and information for U.S. customers available online at www.peavey.com/warranty or use the QR tag below



Features and specifications subject to change without notice.

Peavey Electronics Corporation 5022 Hartley Peavey Drive Meridian, MS 39305 (601) 483-5365 FAX (601) 486-1278



Logo referenced in Directive 2002/96/EC Annex IV (OJ(L)37/38, 13.02.03 and defined in EN 50419: 2005
The bar is the symbol for marking of new waste and is applied only to equipment manufactured after 13 August 2005